

Cabling of the ATLAS liquid argon calorimeters

C. Cerna, J. Colas, W. Cwienk, A. Fischer, J.Y. Hostachy, M. Kazarinov,
D. Lissauer, M. Mathieu, R. McPherson, H. Oberlack, P. Perrodo, P. Poffenberger,
P. Pralavorio, S. Rajagopalan, D. Sauvage, P. Schacht, L. Shaver, W. Tribanek

December 12, 2003

Abstract

The present note describes the cabling of the ATLAS liquid argon calorimeters from the physical cells to the front end crate base planes. The trigger tower summation, the calibration and the high voltage lines are also described. Most of the information given here is based on the liquid argon calorimeter technical design report. However some changes have been made more recently and are given here. So this note supersedes the technical design report.

! DRAFT DRAFT DRAFT DRAFT DRAFT !

1 Introduction

This document describes the mapping of the ATLAS liquid argon calorimeters from the cells to the front end crate. Starting with rules for local frame definition (section 2) and the numbering of channels inside trigger towers (section 3) it describes the correspondance between the physical cells and the baseplane channel pins. It also give the mapping of the calibration lines from the base plane pins to the detector cells. The high voltage lines are also described. The monitoring (temperature probes, purity system, etc...) is left in separate documents referenced in the bibliography.

The information given in this note is already partially described in the ATLAS liquid argon TDR [1]. Some changes have occured since and this note gives the final description of the channel mapping.

Most of the cabling of the calorimeters is periodic over the module. This note decribes only the generic information. In some cases there are peculiarities (e.g. monitoring). They are not given here but in dedicated references. Similarly the cabling might have encountered some local changes during construction (e.g. high voltage lines). This information is also given in separate notes.

2 Local coordinate system

In a system composed of several pieces assembled according to a hierarchy (modules \rightarrow wheel \rightarrow calorimeter) it is convenient to define appropriate coordinate systems. Definitions for the electromgnetic barrel can be found in reference [2]. Starting from the ATLAS general frame (x^A, y^A, z^A) , frames reltaive to each cryostat side or wheels are defined (x^H, y^H, z^H) (H for half-barrel). Then a frame (x^M, y^M, z^M) attached to each module in a wheel is defined (M for module). This frame is reproduced in figure 1 and is called the local frame in this note.

These definitions can be easily extended to the encap electromagnetic and hadronic wheels. As an example a proper definition of this frame for the EMEC wedge is given here:

- z axis: pointing from the interaction point to the EMEC. i.e. the z axis points into the EMEC from strip layer to 2nd and then to 3rd layer. This axis defines the pseudo-rapidity and a positive rotation direction (right handed rotation) i.e. a positive direction for the local azimuthal angle.
- x axis: points to large radius; aligned to the edge of the wedge so that the wedge is at positive.
- y axis: defined such as to get a right handed system.

This frame is shown in figure 1.

The cabling of the HEC wheel is described as at the level of the whole wheel. So the most adapted frame to describe it is the (x^H, y^H, z^H) frame.

The FCAL calorimeter is one piece detector. The most convenient frame to describe each wheel is the (x^H, y^H, z^H) frame.

3 Cell numbering

The channel mapping should obey to the requirements imposed by the analog trigger summation: within a shaper chip all channels belong to the same trigger tower. Trigger

towers and detection cells are defined in the figures 10-3 and 10-4 of the TDR [1] and are repeated here for convenience in figures 2 and 3 for the electromagnetic part.

For the HEC and FCAL calorimeter these figures are not relevant as each trigger tower is not divided into subcells except in depth.

By definition the cell number within a trigger tower starts from 0 and where appropriate, elements are ordered first by increasing local ϕ then by increasing local η . This is shown in Fig. 4.

By definition the layers are numbered from 0 to 3 for the electromagnetic part: 0 for PS, 1 for strips, 2 for middle, 3 for back.

4 Cabling of the electromagnetic calorimeters

The description of the mapping of the electromagnetic calorimeters is done here in a synthetic way. There is in particular no description of how the detector is cabled in practice (this information can be found in specific notes [3]). The description will strick to the following logic: first is described the mapping of the signal from the detector to the base-plane. The starting point is the signal issued from the summing boards. Then the signal goes through :

- the motherboards;
- the A harnesses going from a low profile connector to a female μ -D connector;
- the B harnesses going from a male μ -D connector to a ATI connector;
- the feedthrough with the cold flange, the vacuum cable, the warm flange;
- the warm cable and finally the base-plane.

This circuit is schematized in Fig. 20. From a similar path but in the other way goes the calibration signal from the base-plane to the motherboard. The mapping of the calibration signal is given in the way way the signal mapping. Finally the HV mapping is explained for one module.

4.1 Motherboards

A motherboard reads several trigger towers (usually 4 corresponding to a $\Delta\eta \times \Delta\phi = 0.2 \times 0.2$ zone). The signals come from the summing boards. Schematics views for the barrel motherboards can be found in Fig. 5 for the low radius face of the detector and in Fig. 6 for the large radius face. The part called barrel-end ($\eta > 1.4$ in the barrel) is readout by a motherboard shown in Fig. 7.

For the EMEC an explanation of the cabling of the motherboards can be found in Fig. 8. The five types of front motherboards are shown in Fig. 9, 10, 11, 12, 13. The back motherboards are in the 14, 15, 16, 17 for the outer wheel and Fig. 18 for the inner wheel.

The signals output via the low profiles receptables which have 8 channels for the EMB and possibly 4 for the EMEC. The motherboards hold also receptacles for calibration low profiles which have 4 lines for the EMB and 4 or 2 for the EMEC.

4.2 From the A harness to the Front-End Board

The Fig. 20 shows a schematics of the way taken by the signal to go from the low profile connectors to the Front-End Board. Note that from the low profile level the description of the cabling is similar to all liquid argon detectors (EMB, EMEC, HEC and FCAL) except that for EM presamplers, the HEC and the FCAL where the low profile is replaced by cables directly soldered on the boards in the cold.

The first harness (A harness) goes from low profile connectors (various formats with 2,4, or 8 pins) to a female μ -D connector. The correspondance between the channel number (from 1 to 64 at the low profile level) and the peculiar numbering of the μ -D connector is explained in Fig. 21. More details on harnesses and cables can be found in Ref. [4].

The second harness (B harness) is shown in Fig. 22. It goes from a male μ -D connector to an ATI connector. The channel correspondence is shown for the 64 channels and is the same for all the liquid argon detector.

The ATI connector is plugged into the feedthrough cold flange which is shown in Fig. 23. Each feedthrough flange consists in 30 slots arranged in 2 rows (A and B) of 15 connectors. For each connector the channel numbering is shown on the figure. Between the cold and the warm flange are the vacuum cables schematized in Fig. 24. The warm flange is totally similar to the cold one as far as the electrical mapping is concerned except that it is rotated by 90° .

The warm cable is shown in Fig. 25. It is connected between the feedthrough warm flange and the base-plane. The front-end boards are connected to the base-plane and details of the electrical mapping are shown in Fig. 26.

For some slots of some baseplanes of the end cap cryostats the default-length cables which are used for the connection of the signal feedthrough warm flange to the baseplane (warm cables) are not physically long enough to make the connection. In some cases, this is due to a connection being made from a feedthrough to a the baseplane which lies above the neighboring feedthrough. In other cases, the length deficit is due to the offset in z_{local} relative to the feedthroughs of those pedestals which are located at the bottom half of the cryostat. For those positions where the default-length warm cable will not reach, a long cable must be used. The long warm cables are 33.5 cm face-to-face, as opposed to 28.5 cm for the default-length cables. The crate slots which have the long warm cables are itemized in Table 1. Note that the FCAL crate has no long cables.

Table 1: Baseplane slots which have long (33.5 cm) warm cables connecting the signal feedthrough to the baseplane; all other slots have default-length (28.5 cm) warm cables.

Crate	Crate number	FT connector	Crate slot
Standard	8,10,11,13	14B	18
		15B	19
		01B	21
		02B	22
Special	2,6	01A	19
		01B	19
Special	9,12	15B	18
		01A	19
		01B	19
		02B	21

4.3 Mapping of the signal

The Fig. 27 shows a half module of the barrel electromagnetic calorimeter with the trigger towers ($\Delta\eta \times \Delta\phi = 0.1 \times 0.1$). Each trigger tower has a granularity and a cell numbering already given in Fig. 2 and 3. These figures explain the correspondence between the cell and the feedthrough flange channel labelled by the ATI row (A or B) the ATI slot (from 1 to 15) and the pin number (from 1 to 64). It is shown for the four layers in depth with the special case of the barrel-end region.

Similarly the Fig. 28 shows the signal mapping of a half module of the endcap electromagnetic calorimeter. The same rules for referencing the electrical channels at the feedthrough level are used.

4.4 Mapping of the calibration

In a similar way to the signal the calibration line mapping is described in two steps. First the pattern of the calibration lines within a unit zone of (0.2×0.2) corresponding to a motherboard is explained in Fig. 29. One calibration line pulses the whole zone for the presampler. For the calorimeter 4 lines pulse the front layer, 8 lines for the middle layer and 4 for the back layer. Again the barrel-end is treated separately.

In Fig. 30 the calorimeter is divided in $(\Delta\eta \times \Delta\phi = 0.2 \times 0.2)$ zones and the correspondence between the pins on the base-plane for the calibration line and the cells is given here in terms of low profile number (from 1 to 16). The numbers shown in the figures are channel numbers from 1 to ... within a group a lines pulsing the considered area.

Using a similar philosophy the calibration lines for the EMEC is described in Fig. 31 and 32. Detailed explanations are given the figure captions.

4.5 High voltage lines description

For the barrel, the high voltage is cabled per half-module ($\Delta\phi = 0.2$). The half barrel is divided into 7 zones of size $\Delta\eta = 0.2$. Each zone has two high voltage lines for both sides of the electrodes. There are two HV connectors of 8 lines per half-modules called HV1 and HV2 (see Ref. [3]). Only the 7 first lines are used in a standard half-module. The 7 lines of the HV1 (resp. HV2) connector supplies the 7 zones in η for the gap located at small (resp. large) ϕ . For some half-modules, the 8th lines are used as spare lines. This special mapping is described in Ref. [5].

For the End-Cap, the high voltage is cabled in the region $1.375 < \eta < 2.5$ (outer wheel) by quarter of module ($\Delta\phi = 0.2$) and in the region $2.5 < \eta < 3.2$ (inner wheel) by eighth of module ($\Delta\phi = 0.1$). In the η direction, one End-Cap is divided in nine zones as shown on figure 19. As in the barrel each zone has two high voltage lines for both sides of the electrodes. EMEC high voltage sectors are defined as cells of, one η HV sector (F,B1,... B8) by one ϕ_{local} HV sector (4 for the Outer Wheel and 8 Inner Wheel in a module) and by one HV side. Therefore one module has 88 independent sectors, each supplied by one HV line. HV lines are grouped eight by eight on eleven HV ATI connectors such as :

- for the outer wheel, one HV ATI connector of eight lines corresponds to one η sector (4 ϕ sectors and 2 HV sides) ;
- for the inner wheel, one HV ATI connector of eight lines corresponds to a half η sector (4 ϕ sectors (from 1 to 4 or 5 to 8) and 2 HV sides).

In one HV ATI connector the height lines are labelled P1 to P8. The $P_{odd(even)}$ lines corresponds to the HV side 1 (2) in increasing ϕ sectors.

In addition to the eleven HV ATI connectors, each module has one spare ATI connector to isolate possible problematic zones.

4.6 Warm flanges and front end crates

Each feedthrough flange has 2 rows of 15 connectors (with 64 pins each). The function (signal, calibration, low voltage, monitoring) of each connector is described in Fig. 33 for the EM barrel (details on the barrel feedthroughs can be found in Ref. [6]). The 64 EMB feedthrough flanges are identical except for some special monitoring functions. Details can be found in Ref. [7, 8] for the EM barrel part. More generally monitoring information is summarized in Ref. [9]. For the EMEC the flange for the standard feedthrough is shown in Fig. 34. The special EMEC flange can be found in Fig. 35. A small part of the EMEC remains in the HEC flange. The HEC flange is described in Fig. 36. Finally the FCAL flange can be found in Fig. 37. Historically the former NA31 cryostat has been used for EMEC cold tests. Its feedthrough flange layout is shown in Fig. 38.

On top of the feedthrough flanges are the front-end crate. There is one crate attached to 2 feedthroughs except for the FCAL. Each crate contains 38 boards slots. The correspondence between the flange connectors and the FEC slots are shown for the various feedthroughs in Fig. 39 for the EMB, Fig. 40 for the EMEC standard Fig. 41 for the EMEV special and the HEC. For the FCAL the two cryostats A and C are not identical by mirror imaged. The front-end carte description for the two FCAL cartes on A and C sides can be found in Fig. 42 and Fig. 43 (for any endcap feedthrough and baseplane connections, please refer to [11] for details).

Each crate has a baseplane board where the front-end boards are plugged. The positions of the various boards described in the previous figures is closely related to the baseplane design. Technical drawings of these baseplanes can be found in Ref. [10].

5 Cabling of the hadronic calorimeter

The signal (SI), low voltage (LV), high voltage (HV) and calibration (CA) lines set different demands in terms of timing, safety, feed-through connections and requested accessibility.

5.1 Overall Layout

The Fig. 44 shows the layout of the lateral and longitudinal segmentation of a front and rear module. The Fig. 45 shows the two HEC endcaps with the related module numbering scheme. The Fig. 46 and Fig.47 show the overall cabling scheme for the HEC in the $R - \phi$ view: One feed-through per quadrant serves the related 8 modules with SI, CA and LV lines, while all HV lines are supplied through one separate feed-through. The SI and CA cables have to guarantee the same arrival time of the signals at the front-end electronics taking into account the flight time of the particles in the calorimeter. These cables are routed from the feed-through via ‘pigtailed’ to patch panels fixed to the backplane of the rear wheel (HEC2). To match the requirement of equal cable length, additional space for the extra cable length has to be reserved. An area extending at the backplane over 1200 mm in R and 100 mm in z is reserved for this extra cable length (hatched area in $R - \phi$ view).

For each quadrant the signal cables running from the electronics motherboard of each module to this patch panel have to be of equal length as well. Therefore an additional space

on the backplane of each module is reserved for this extra cable length ('module cabling'). This space for signal and calibration cables has to be shared with the various distribution boards (calibration, high voltage, temperature probes, purity probes) required per module.

The readout channels of the front and rear wheel have to be regrouped at the patch-panel: In order to make use of the 4-channel trigger summing at the level of the FEB, each η channel has to have the three related longitudinal readout channels neighbouring. Therefore the signal cables of the HEC1 are routed in ϕ to match the appropriate quadrant cable trail, are then routed to the backplane of the HEC2, and there again in ϕ to the appropriate patchpanel. The reserved space for these signal and calibration cables is again the 'module cabling' space at the backplane of the HEC2.

The Fig. 48 ($R - \phi$ -view) and Fig. 49 ($R - z$ -view) show the cabling scheme for the signal lines.

The Fig. 48 shows also the distribution of the various patchpanels at the backplane of the rear wheel HEC2. For the signal cables three patchpanels in η are foreseen, each serving two ϕ -wedges, with 64 cables each (see Fig. 54). The calibration patchpanel serves four ϕ -wedges, with 64 lines in total.

The HV cables use a separate feed-through and are not restricted to equal cable length. They are routed from the feed throughs to patchpanels at the backplane of HEC2 and from there to the backplane of HEC1 or HEC2 respectively. Here they are distributed in $R - \phi$ as indicated in Fig. 50 and in $R - z$ as indicated in Fig. 51.

The Fig. 52 shows finally the space allocated to the various distribution boards (calibration and high voltage) at the backplane of each module and the space reserved for extra cable length ('module cabling'). Shown is also the coverplate fixing these cables to the backplate of the module.

5.2 Signal Lines

As said above, Fig. 44 shows the general lateral and longitudinal segmentation of a module. Notches for signal, calibration and HV lines are indicated (on the side of the module) as well.

Based on the feed-through allocation, the signal lines are symmetric with respect to individual quadrants. The demand for equal channel timing sets tight limitations on the cable length variation for the signal output cables (from the motherboard to the feed-through). To have a minimal timing spread between the signals from individual electrodes which are being summed to one read-out channel, the cabling has to follow as closely as possible the real particle shower propagation.

The Fig. 53 shows the strip line connector (50Ω impedance) which guides the individual electrode signals referring to one read-out sub-segment to the motherboard. The back plane serves as ground bus. All conducting surfaces are gold plated. This connector runs perpendicular to the 25 mm (or 50 mm) copper plate orientation in notches of 39 mm width and 3 mm depth. Two read-out electrodes are added locally to one line. The connector serves two radially adjacent read-out sub-segments in parallel and runs over 8 copper plates. Small tabs (with soldered pins) from the signal electrodes are passed through holes in the strip line connector to special sockets. Close to the end of the connector the transition from the strip line to the 50Ω impedance coax cable is done via a soldered joint. These cables leave parallel to the copper plate orientation in special notches and run directly to

the related motherboard at the outer ($R = 2.03 \text{ m}$) cylindrical surface of the module. For the longitudinal read-out segment 2, where 16 rather than 8 read-out electrodes are summed, a second strip line connector is added. For this read-out segment two strip line connectors are used. The corresponding calibration lines are connected via a jumper cable, which is soldered to the strip line connector. The calibration input cables are fed in close to the beginning of the strip line connector via notches parallel to the copper plate, thus simulating the evolution with time of a real particle response as close as possible.

The signal output cables are connected via connectors at the motherboards (each connector uses up to 8 lines, there are 6 connectors for the front module and 6 connectors for the rear module). These output cables are routed on top of each other to the back plane of the module, regrouped within the quadrant and routed to the patchpanel at the backplane of the rear wheel HEC2, with the boundary condition of equal length. The cabling is done symmetrically for each quadrant. Therefore for each module at the back plane some space is reserved to store the extra cable length. The Fig. 52 shows schematically the space allocation at the back plane of a module.

Finally the Figs. 54 and 55 show the cabling scheme for one quadrant of the endcap A and endcap C wheel from the patch panels at the backplane of HEC2 up to FEB boards, including the feed-through connections.

5.3 Calibration Lines

In order to have the calibration signal match the real signal as closely as possible, the calibration pulse is fed in at the level of the electrode. Therefore, additional calibration lines deliver the calibration signal to all electrodes served by the signal strip line connector. Given the requirement of 50Ω impedance over the full length of the distributionline, one calibration line can serve at most 32 read-out electrodes in reality.

An important constraint for the distribution of the calibration lines is the dynamic range required at the level of an individual preamplifier and at the level of the summing. For the first and last longitudinal segments the dynamic range at both levels is identical, i.e. the maximum signal at the summing stage corresponds to the sum of the maximum of the preamplifiers being summed in this particular read-out tower. Consequently one calibration line is in this case sufficient to pulse all read-out electrodes of this read-out tower in parallel. Therefore the signal connector in the rear wheel has in general one common calibration line, pulsing two radially adjacent read-out electrodes with 16 pads each. Calibrating two neighbouring read-out electrodes in parallel precludes the measurement of the related cross talk. However this measurement has been done in module -1, yielding typical values for this cross talk at the level of 1%. Since this level is so small the chosen technique seems to be adequate. For those channels, where a lateral summation has to be done as well (low η region), two calibration lines rather than one are being used. This limits the total number of preamplifiers being pulsed (in parallel) and being summed to one readout channel, to a maximum of 8.

In the second longitudinal read-out segment there is a difference of a factor of two between the dynamic range required at the preamplifier level and at the summing stage. Therefore two calibration lines are required for a given read-out tower, one pulsing the first eight read-out electrodes and one the second eight read-out electrodes. Therefore a different calibration scheme has been adopted for the front wheel (HEC 1). Each signal connector, which covers 8 read-out electrodes, has two calibration lines. In the first longitudinal read-out segment this line feeds all eight read-out electrodes, the dynamic range requirements being here identical to the last longitudinal read-out segment. The second longitudinal read-out segment is covered by two signal connectors, each one extending over

eight read-out electrodes. The calibration signal is ganged from the signal connector of the first longitudinal read-out segment to the first signal connector of the second longitudinal read-out segment via jumpers. Before passing on to the second signal connector of the second longitudinal read-out segment the two calibration lines are swapped. In the front wheel the maximum number of preamplifiers being pulsed (in parallel) and summed to one readout channel is 4.

The cabling for the calibration lines is symmetric for one quadrant (see the Figs. 54 and 55). We foresee the calibration cables running from the feed-through to a small calibration distribution board at the back plane of each module via patch panels at the backplane of HEC2. The space reserved for this board is about 15×4 cm . The maximum voltage required for the calibration pulse is 1.7 V. This is a factor of three less than the voltage available (5 V). Therefore each calibration line is fanned out to three lines at the distribution board, which then are routed to the strip line connectors. The cable lengths must again be equal, and so a dedicated region at the back plane of the module will be used to store extra cable.

The calibration input cables are routed from the board on the back plane, to the outer radius of the wheel, then under the motherboards, and finally along slots in the copper plates to the front of the strip line connector in the first and third read-out segment. The space reserved at both sides of the motherboard accomodates up to 28 cables. The calibration cables are then soldered to a trace that runs down the connector. A set of $5 \text{ k}\Omega$ resistors connects the calibration line to the signal line (see Fig. 53), providing the means to input the calibration signal directly to the signal lines.

In this layout each calibration line feeds up to 24 electrodes in the front module and up to 32 electrodes in the rear module. In total 10 calibration lines are required for the front module and 6 calibration lines for the rear module.

The assignment of individual calibration lines to signal pads (numbering see the Fig. 44) channels is shown schematically in the Fig. 56 and the Fig. 57 for the left or right side of the front and rear module respectively.

5.4 High Voltage Cables

The connection of the HV and ground to the read-out board (ROB) and EST is done following the strip line connector technique, again done on the side of the module. For each readout section we foresee to supply 4 independent HV lines, feeding the EST 1, EST 2, ROB 1 and ROB 2 HV potentials. Two ground connections (EST 1 and EST 2) are required in addition. For safety and to limit any current due to pile-up, two HV connections are foreseen for each plane: one close to the inner radius and one at the outer ($R = 2.03 \text{ m}$) cylinder surface of a module. The HV connection to the strip line connector is done via tabs similar to the signal connection (see Fig. 58). The tabs are isolated (kapton) on the side facing the module. The non-isolated plane of the tab is covered - as in the case of the signal lines - with a kapton sheet placed in the inter module gap prior to the wheel assembly. Therefore we can connect with each strip line connector two HV lines and one ground line. For the connection of the remaining three lines the identical strip line connector is rotated by 180 degrees. The ground tabs run in the center and terminate at screws mounted to the copper plates. Two HV buses run on each side and serve for the parallel connection of related planes of 8 LAr gaps. Close to each tab is a $0.5 \text{ M}\Omega$ resistor.

All HV lines (4 per section of 8 copper plates) are guided to a HV distribution board at the back plane of a module. Here one additional resistor of $0.1 \text{ M}\Omega$ is added to each HV

Board in LV box (position: tile finger)	FEC slot	FT connector	LV-patch-panel (quadrant cabling)	Φ -wedge
LV-DIS-1	38	15 A	LV-P 1	1
LV-DIS-1	38	15 A	LV-P 1	2
LV-DIS-2	38	15 B	LV-P 2	3
LV-DIS-2	38	15 B	LV-P 2	4
LV-DIS-3	37	14 A	LV-P 3	5
LV-DIS-3	37	14 A	LV-P 3	6
LV-DIS-4	37	14 B	LV-P 4	7
LV-DIS-4	37	14 B	LV-P 4	8

Table 2: HEC LV cabling scheme for one quadrant. Shown is the connection from the low voltage power box in the tile finger up to the related Φ -wedge in the quadrant.

line.

As in the case of the signal strip line connector, the HV cables are soldered to the strip line connector prior to mounting the connector at the module. After module assembly these lines are connected (pins and sockets) to the HV distribution board, which is mounted at the back plane. In order to provide the required HV ganging scheme, the lines in the notch of the front(rear) module, will be connected to 8(8) independent HV lines so as to provide four independent lines to each read-out depth. The input HV lines (from the feed-through) are connected via a connector at this board. Because of accessibility this connector has to be as close as possible to the inter module gap. Because each HV line splits into 2 lines, space has to be foreseen for guiding up to 8 HV lines from the low-r to the high-r region at the back plane of the module. The size of the HV distribution board is 13.3×9.6 cm.

Further HV lines connect these HV ‘module distribution boards’ with the HV ‘quadrant distribution boards’ at the backplane of HEC 2 (see Fig. 48): each distribution board serves one quadrant of either HEC 1 or HEC 2, adding up to a total of 8 distribution boards. Finally the ‘pigtailed’ of the HV feed-through are connected to these ‘quadrant distribution boards’.

The final connection from this HV distribution board to the relevant feed-through (one for the whole wheel) is of varying length, depending on the module position within the wheel, and has to be added after insertion of the wheel into the cryostat.

5.5 Low Voltage Lines

The low voltage lines (4 per motherboard) are connected via connectors at the motherboard. They are routed to the back plane of the module, passing again on either side of the motherboard and further via cabletrays (HEC1) up to the LV patchpanels at the backplane of HEC2. The low voltage lines coming from the feed-through are connected via connectors to this board. The Table 2 and the Figs. 54 and 55 show the LV cabling scheme for one quadrant.

The variation of the length of the low voltage lines is not a critical issue. On the other hand we would like to maintain a standard voltage drop across the cable for all low voltage lines of a given wheel. Therefore the cable length for each wheel has been kept fixed. The low voltage cabling being symmetric for each quadrant has thus to allow for extra cable length at the backplane of each module.

The mapping between the baseplane channels and the corresponding blocks and pins of

the pigtail cables of the HEC low voltage lines is given in Table 3. Note that this mapping differs from the earlier design effectively by a swapping of the baseplane channels $Ai \Leftrightarrow Ci$ for each $i = 1 \rightarrow 32$. This difference is due to a manufacturing error in the low voltage pigtail cables, where the two rows of sockets of the ATI connector were interchanged, or equivalently, the two rows of pins of each pigtail block were interchanged.

6 Cabling of the Forward calorimeter

The Forward Calorimeter (FCAL) is composed of three separate wheels (FCAL1, FCAL2, FCAL3), each consisting of a single monolithic module. Hence, the situation for FCAL cabling is somewhat different from the other LArG detectors, since a module and a wheel are identical.

In the case of the FCAL, there is no convenient geometrical feature to use to define a local coordinate system (LCS). Therefore, we simply define the FCAL LCS to be identical to the global coordinate system (GCS) in the case of FCAL-A, and to be a mirror-image of the GCS in the case of FCAL-C. This GCS is identical to the coordinate system attached to a EM wheel and denoted (x^H, y^H, z^H) above in Section 2.

6.1 Basic signal organization

Each FCAL module can be considered to be a hexagonal close-packed array of tubular electrodes parallel to the beam direction, read out at one end of the electrode. Signals from small groups of electrodes are added by means of direct connection at the electrode ends. Signal connections are made on the near face (to the IP) for FCAL1, and at the far face of FCAL2 and 3. For the case of FCAL1(2){3}, these electrode groups consist of 4(6){9} electrodes (see Fig. 59). These signals then are carried by the cold cable harnesses (similar to A harnesses in the case of the EMB) to summing boards where they are summed again in groups of four adjacent electrode groups to produce the signal from a read-out tile. The summing board outputs are then carried to the feedthrough by the feedthrough pigtails. Summing board circuits are entirely passive, with no low voltage power required.

In order to both fit the hex-packed electrode array into the round boundary edges at the inner and outer module boundaries and to achieve optimal read-out tile counts and read-out tile size, each module does have some read-out tiles that consist of single electrode groups, with no 4-fold summing action occurring on the summing board for that read-out tile.

Each FCAL module is organized into 16 phi slices (see Fig. 60), with the FCAL1(2){3} module having nominally 64(32){16} read-out tiles per phi slice. All FCAL summing boards have identical layouts, with 64 summing circuits per board, therefore FCAL1(2){3} has 16(8){4} summing boards associated with it, for a total of 28 summing boards per FCAL. This results in a summing board covering 1(2){4} phi slices for FCAL1(2){3}.

With each FEB corresponding to two feedthrough pigtails, one has 8(4){2} FEBs for FCAL1(2){3}, giving a total of 14 FCAL FEBs per end. All FCAL FEBs are in a single crate, per end, located at top center of the cryostat, and use a single feedthrough and baseplane. Due to the mirror-symmetry of the cryostats, the FCAL uses different sides or halves of the FCAL crate at each end of ATLAS.

Within each phi slice, read-out tiles are numbered sequentially from the outside inward (ie increasing eta) based on the x,y geometric center of each read-out tile. A numbering convention is used as follows: AB.CC.DD where A is either the A or C end of ATLAS B is 1, 2, or 3 for FCAL1,2,3, CC is 0-15 for phi slice, DD is 0-63 for the tile number.

6.2 Cables

The FCAL uses Axon 25Ω coax cable made into 64 channel harnesses for connection between the module electrodes and the summing boards. A 100 pin micro-D connector is used at the summing board end, and the cable is directly soldered to individual interconnect boards at the module end. Each interconnect board plugs onto the signal pins of one electrode group.

Each of the four harnesses feeding each summing board carries the signals from the electrode groups of 16 read-out tiles. Organization of signals within the harness is optimized to reduce variation in cross-talk. Each micro-D connector has 4 rows of pins. The four input signals corresponding to one read-out tile appear each on a different row. The FCAL feedthrough pigtailed are 25Ω , 4.3 meters long, and plug directly to the summing board output connectors.

6.3 Trigger Towers

Each FCAL module is divided into trigger towers, 4 (1 through 4) in eta, 16 (A through P) in phi (see Fig. 60). This results in a trigger tower being composed of $16(8)\{4\}$ read-out tiles for FCAL1(2){3}. In the case of FCAL3, then the 4-fold shaper chips unweighted sum output is the trigger tower signal. For FCAL1(2), the layer summing boards on the FCAL2 FEBs do a 4(2)-fold weighted sum to produce the trigger tower signal.

6.4 High voltage

First, it is noted that the FCAL uses much lower values of HV than the other LArG detectors, with nominal values of $250(375)\{500\}$ volts for FCAL1(2){3}. (The value is different for different FCAL modules due to the different sensitive gap width for each module. This yields nearly identical E field values.)

High voltage is carried to the electrodes on the signal cables themselves, with each summing board input line having a HV blocking capacitor. It is important to note that there is no HV on the feedthrough pigtailed.

Each summing board has four HV inputs, labeled A-D. In order to achieve a design resistant to failure of an HV supply, each of the four electrode groups corresponding to a single read-out tile is connected to a different HV supply. Therefore, every read-out tile has connections to it from each of the 4 HV supply inputs.

Bearing in mind the unsummed read-out tiles, the order of HV line connections to each summing cell of the summing board is varied in an attempt to equalize (as much as possible) the current demand on the various HV lines. This also yields a design where by the current draws on the various HV lines should act as a measure of how centered the FCAL is to the beam.

6.5 Calibration

For the FCAL, calibration signals are not carried to the detector by dedicated calibration lines, but are instead carried on the signal cables themselves. Therefore the calibration pulser board produces signals which are distributed on traces in the FCAL baseplane to the FEB inputs. Therefore, one has both an immediate calibration signal and (more interestingly) a calibration signal coming from the reflection from the electrode end. Due to this design, no feedthrough connectors are used by the FCAL calibration system.

6.6 Monitoring

The FCAL monitoring signals (temperature and LAr purity) are handled by other feedthroughs. The FCAL feedthrough carries no monitoring signals.

References

- [1] ATLAS Collaboration, *liquid argon calorimeter technical design report*, CERN/LHCC/96-41.
- [2] P. Perrodo, *Frame and numbering definitions for the ATLAS electromagnetic barrel calorimeter*, ATLAS Note, ATL-AB-EN-0013.
- [3] M. Cailles et al., *Cabling procedure dor the ATLAS electromagnetic barrel calorimeter modules*, ATLAS Note, ATL-AB-EN-0014.
- [4] *PRR of LArg Cold Cables*, ATC-RA-ER-0003
- [5] P. Perrodo, *Description of the HV channels for the EMB modules*, ATLAS Note, ATL-AB-EN-0018.
- [6] R. Hackenburg, T. Muller and M. Leite *Cabling of the LAr barrel calorimeter feedthroughs*, ATL-AB-AN-0001
- [7] P. Perrodo, *Cabling and installing the monitoring on the ATLAS electromagnetic barrel calorimeter*, ATLAS Note, ATL-AB-EN-0015.
- [8] P. Perrodo, *Cabling the cryogenics and ring probes on the EMB modules*, ATLAS Note, ATL-AB-EN-0016.
- [9] R. McPherson and P. Puzo, *Monitoring slots in the LARG Front ENd crates* ATL-AL-EN-0047.
- [10] Baseplane drawings on EDMS:
 - ATL-AL-ED-0001 for the FCAL calibration board
 - ATL-AL-ED-0002 for EC standard baseplane
 - ATL-AL-ED-0003 for EC special baseplane
 - ATL-AL-ED-0004 for EMB baseplane
 - ATL-AL-ED-0005 for HEC baseplane
 - ATL-AL-ED-0006 for FCAL baseplane
- [11] M. Fincke-Keeler, M. Lefebvre and P. Poffenberger, *Cabling of the Endcap Signal Feedthroughs*, ATL-AE-AN-0002.

baseplane channel	pigtail block / pins	baseplane channel	pigtail block / pins
A-1	no connection	C-1	no connection
A-2	B2 / 1-2	C-2	B2 / 15-16
A-3	B2 / 3-5	C-3	B2 / 12-14
A-4	B2 / 6-8	C-4	B2 / 9-11
A-5	C2 / 1-2	C-5	C2 / 15-16
A-6	C2 / 3-5	C-6	C2 / 12-14
A-7	C2 / 6-8	C-7	C2 / 9-11
A-8	E2 / 1-2	C-8	E2 / 15-16
A-9	E2 / 3-5	C-9	E2 / 12-14
A-10	E2 / 6-8	C-10	E2 / 9-11
A-11	D2 / 1-2	C-11	D2 / 15-16
A-12	D2 / 3-5	C-12	D2 / 12-14
A-13	D2 / 6-8	C-13	D2 / 9-11
A-14	A2 / 1-2	C-14	A2 / 15-16
A-15	A2 / 3-5	C-15	A2 / 12-14
A-16	A2 / 6-8	C-16	A2 / 9-11
A-17	no connection	C-17	no connection
A-18	B1 / 1-2	C-18	B1 / 15-16
A-19	B1 / 3-5	C-19	B1 / 12-14
A-20	B1 / 6-8	C-20	B1 / 9-11
A-21	C1 / 1-2	C-21	C1 / 15-16
A-22	C1 / 3-5	C-22	C1 / 12-14
A-23	C1 / 6-8	C-23	C1 / 9-11
A-24	E1 / 1-2	C-24	E1 / 15-16
A-25	E1 / 3-5	C-25	E1 / 12-14
A-26	E1 / 6-8	C-26	E1 / 9-11
A-27	D1 / 1-2	C-27	D1 / 15-16
A-28	D1 / 3-5	C-28	D1 / 12-14
A-29	D1 / 6-8	C-29	D1 / 9-11
A-30	A1 / 1-2	C-30	A1 / 15-16
A-31	A1 / 3-5	C-31	A1 / 12-14
A-32	A1 / 6-8	C-32	A1 / 9-11

Table 3: Mapping between the channels of the baseplane and the blocks and pins of the pigtail cables of the HEC low voltage channels.

Local coordinate systems

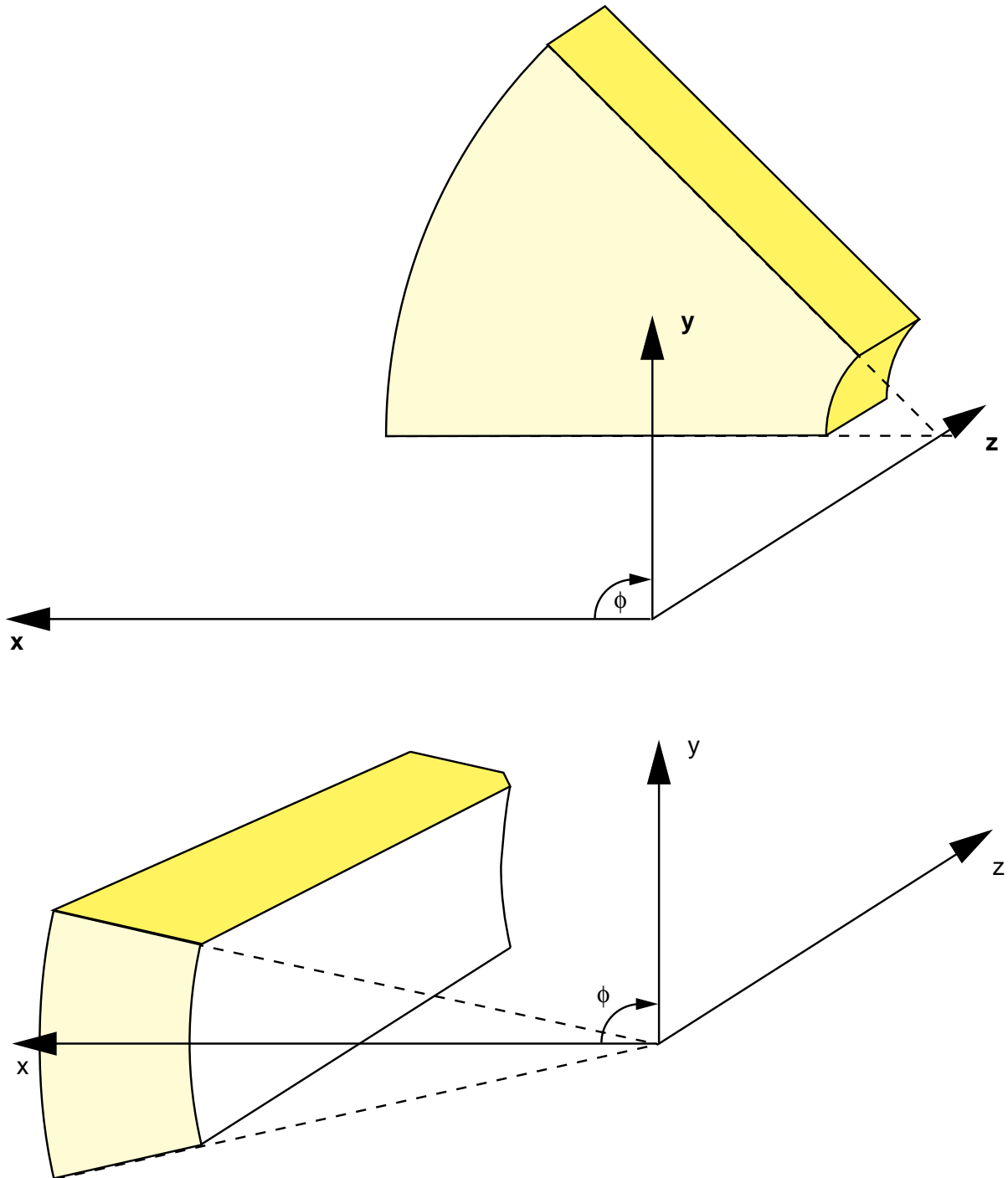

Figure 1: Definition of the local coordinate system for a EMB and EMEC module.

Granularity of the trigger towers for the EMB

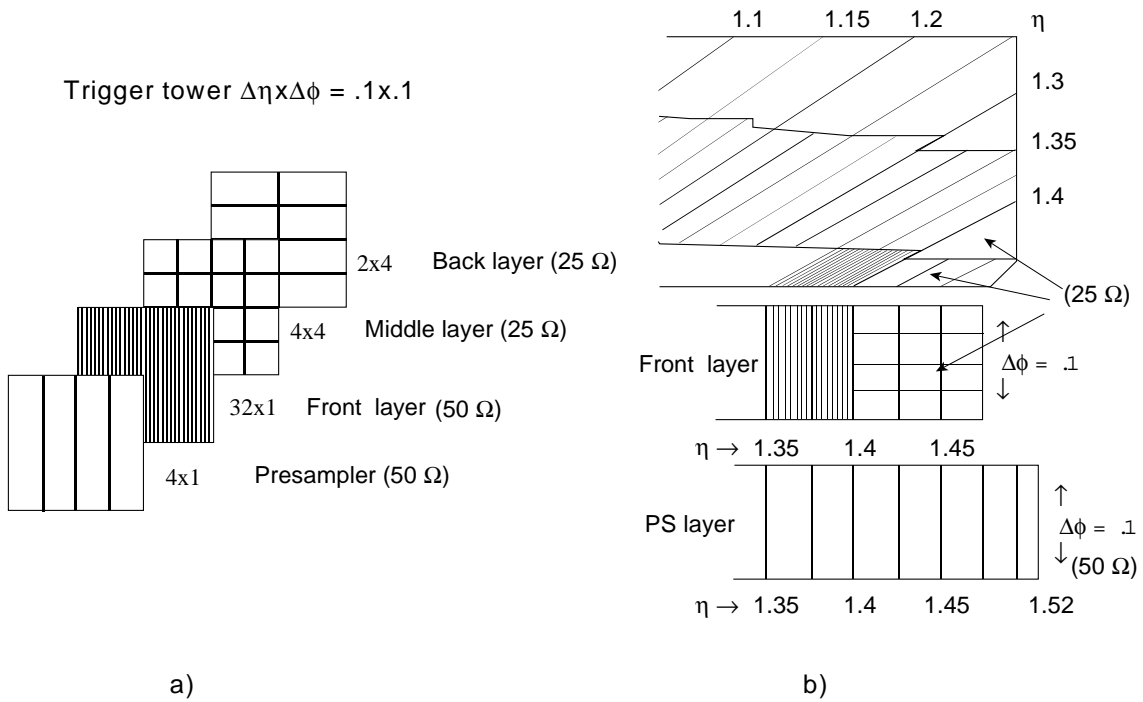

Figure 2: a) Granularity within a trigger tower of the EM barrel ($|\eta| < 1.4$). There are 64 such trigger towers in azimuth and 2 x 14 in rapidity. b) Granularity at the end of the barrel ($|\eta| > 1.4$) in r - η and r - ϕ views.

Granularity of the trigger towers for the EMEC

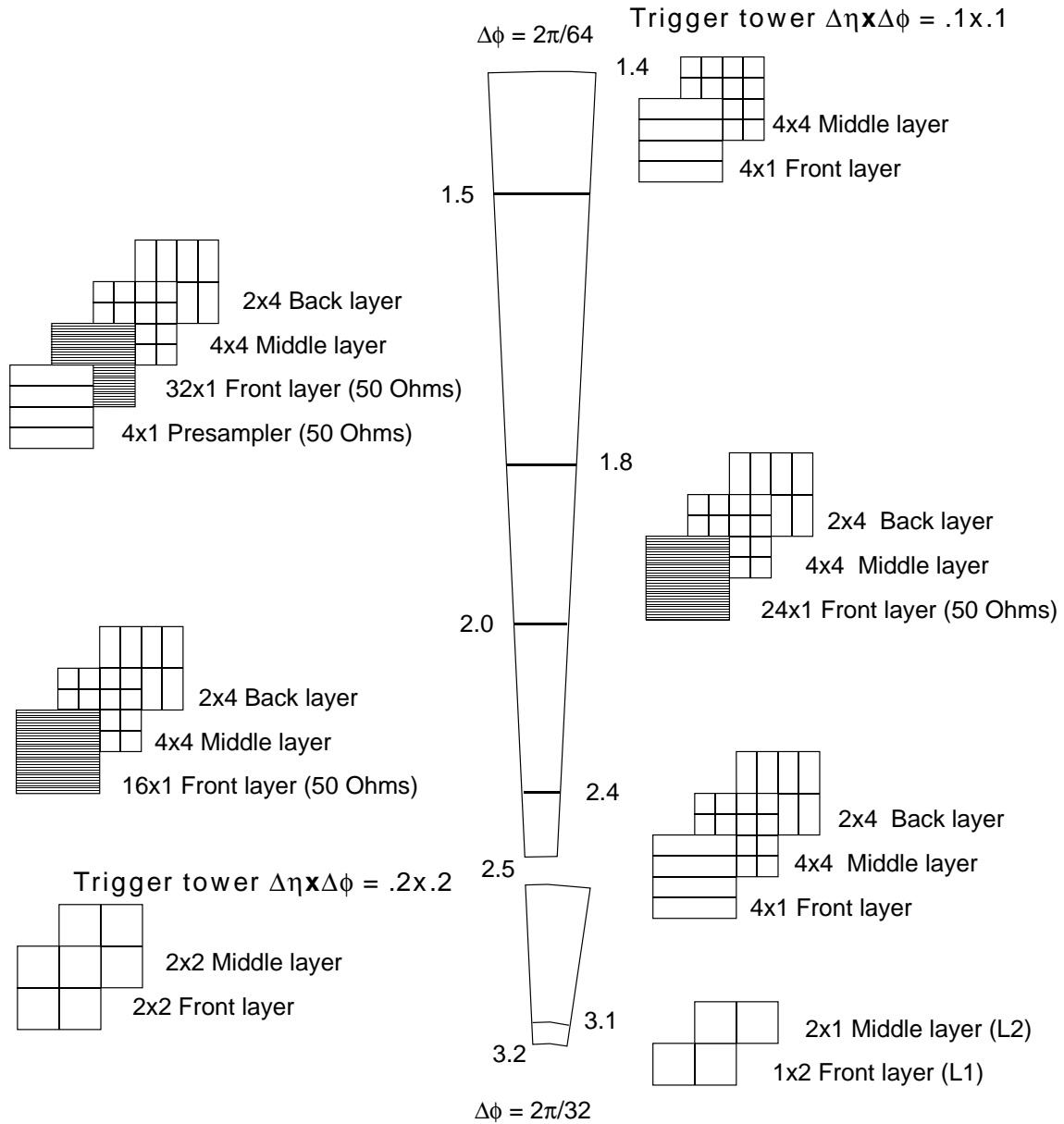

Figure 3: Granularity within a trigger tower in the EMEC. This pattern repeats itself in azimuth. The impedance is 25Ω by default unless specified. Note the change of granularity for $|\eta| > 2.5$. Note : L1 and L2 refer to the text written on the base plane (see Figure 41).

Cell Numbering within a trigger tower

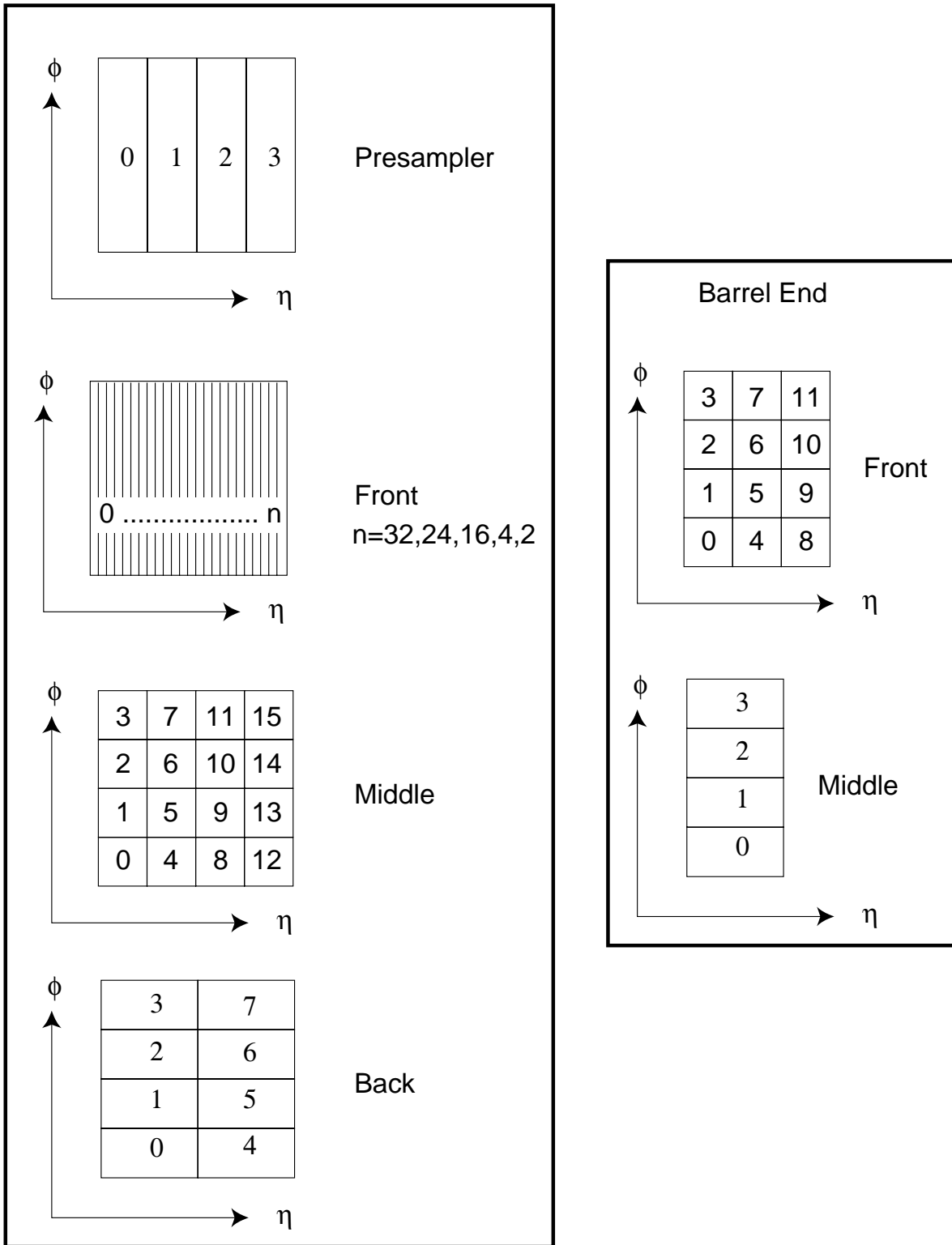
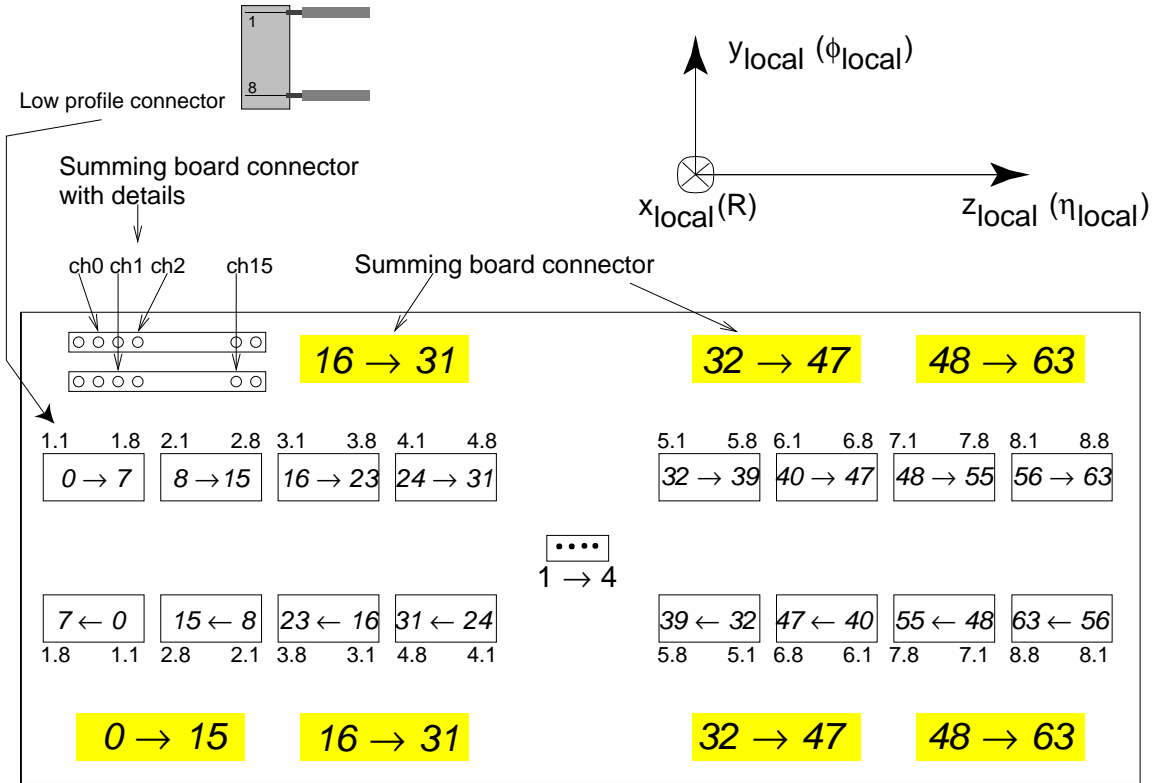
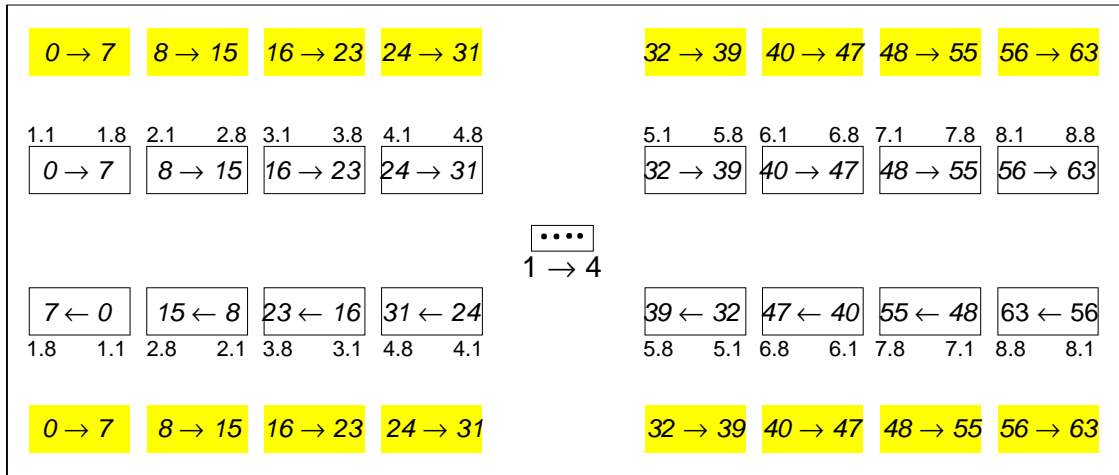

Figure 4: Cell numbering inside of a trigger tower for the EM detectors.

Barrel Front Mother Board



MB mapping for Front strips ($\eta_{\text{local}} < 0.8$)



MB mapping for Front strips ($0.8 < \eta_{\text{local}} < 1.4$)

Figure 5: Front motherboards for the region $\eta < 0.8$ and $0.8 < \eta < 1.4$. The way the summing boards are connected to the motherboard is detailed for the first connector. Numbers in italic refer to cell numbers derived from figure 4. Numbers in roman refer to pin numbers on the A harness (see Figure 21).

Barrel Back Mother Board

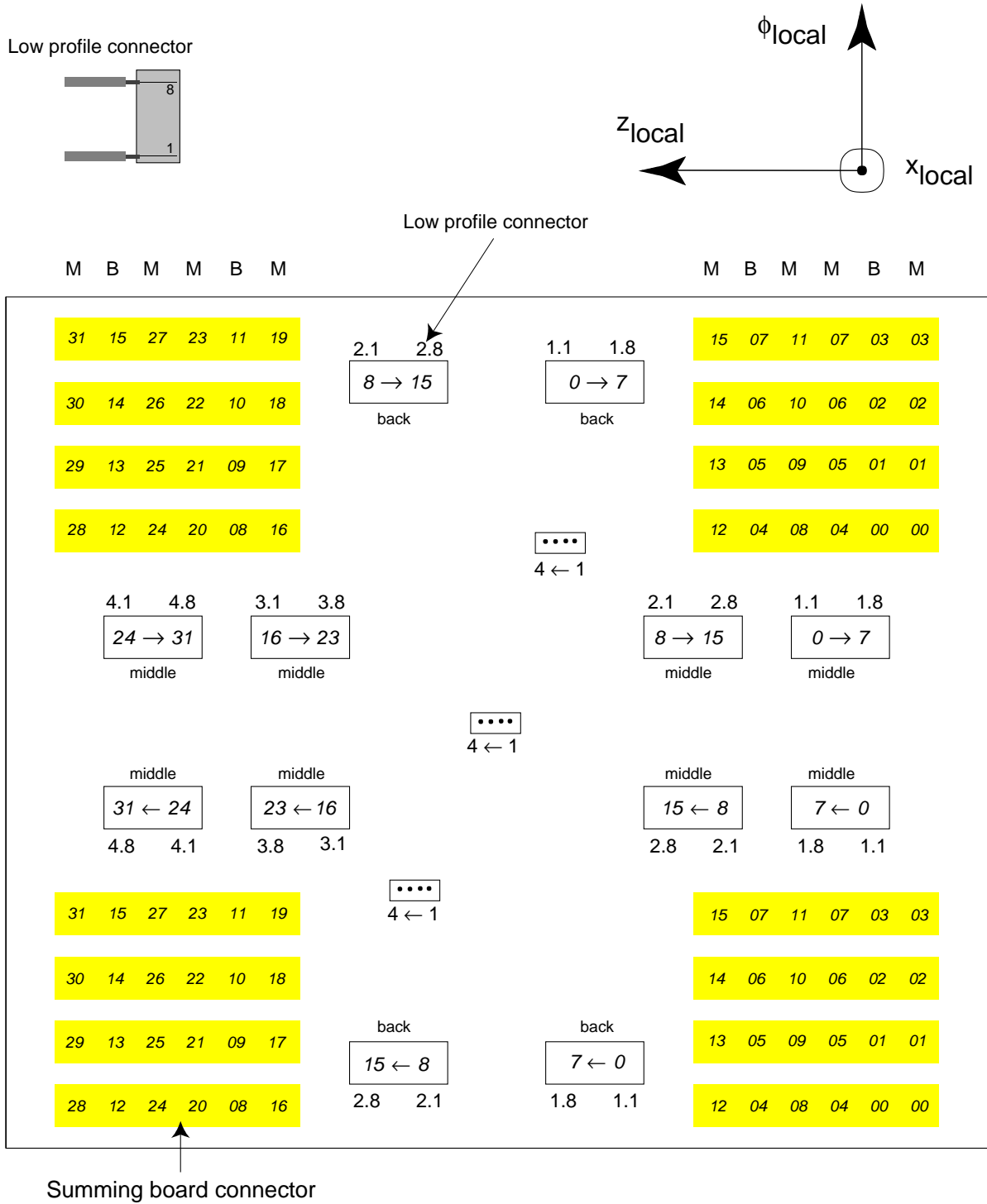

Figure 6: Back mother boards for the EMB calorimeter. Numbers in italic refer to cell numbers derived from figure 4. Numbers in roman refer to pin numbers on the A harness 21.

Barrel End Mother Board

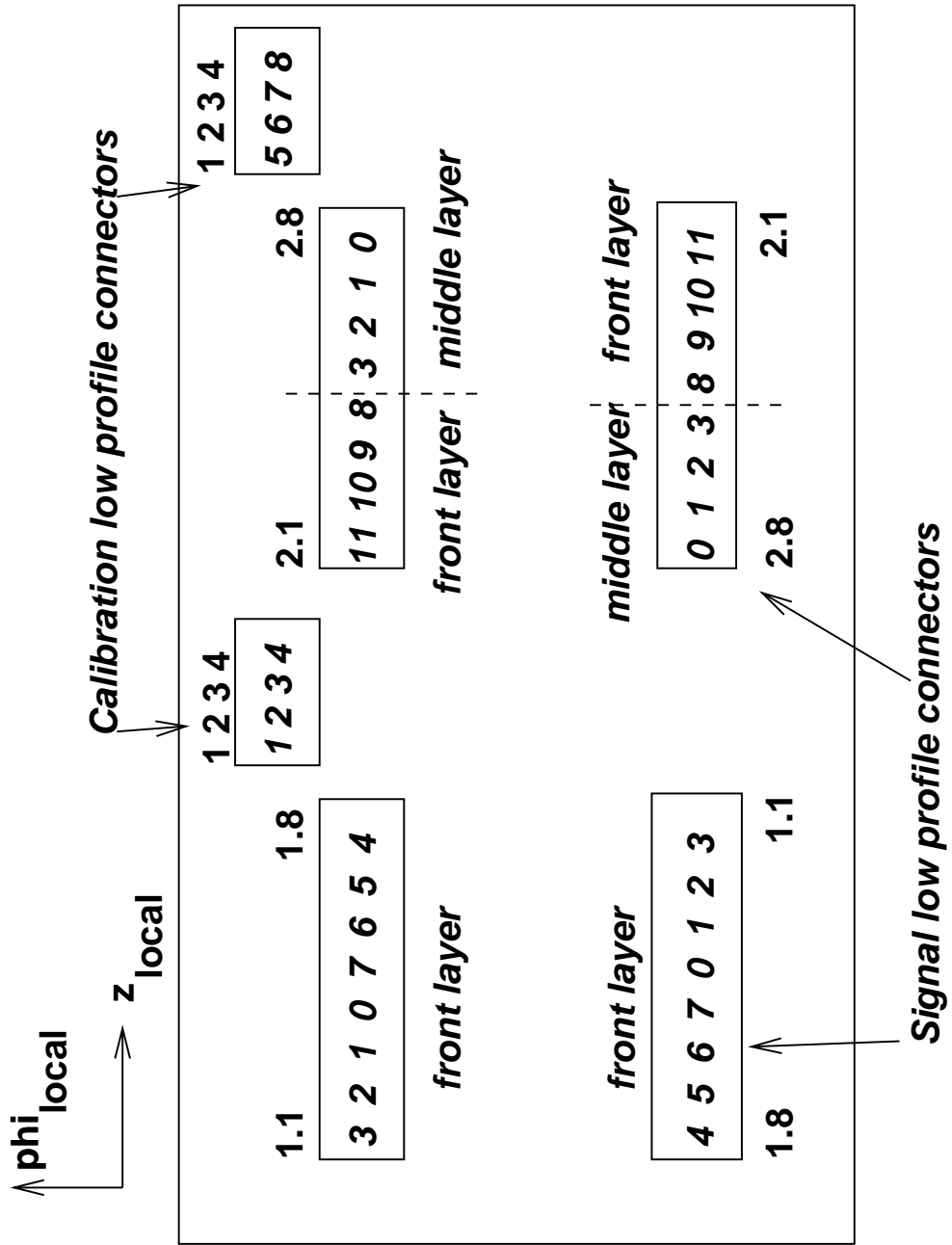

Figure 7: Motherboard for the barrel end region ($1.4 < \eta$). Numbers in italic refer to cell numbers derived from figure 4. Numbers in roman refer to pin numbers on the A harness (see Figure 21) Note the peculiar correspondance between cell numbers and electronic channel numbers.

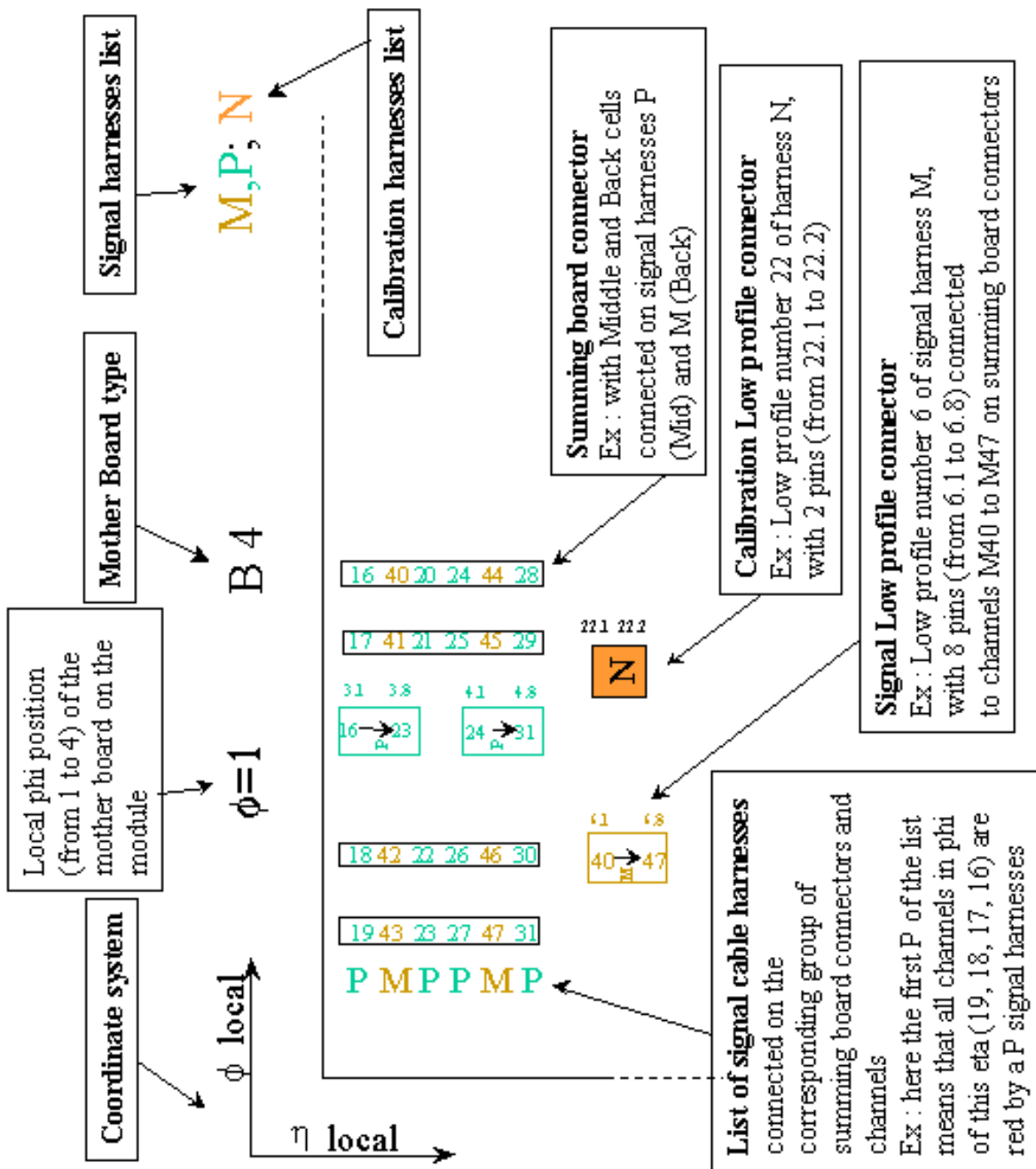

Figure 8: Typical view of the EMEC mother boards schemes presented in figures 9 to 18 to understand how to read them. Note that local $\phi = 1$ position correspond to the first serial of mother board in ϕ_{local} on a given module.

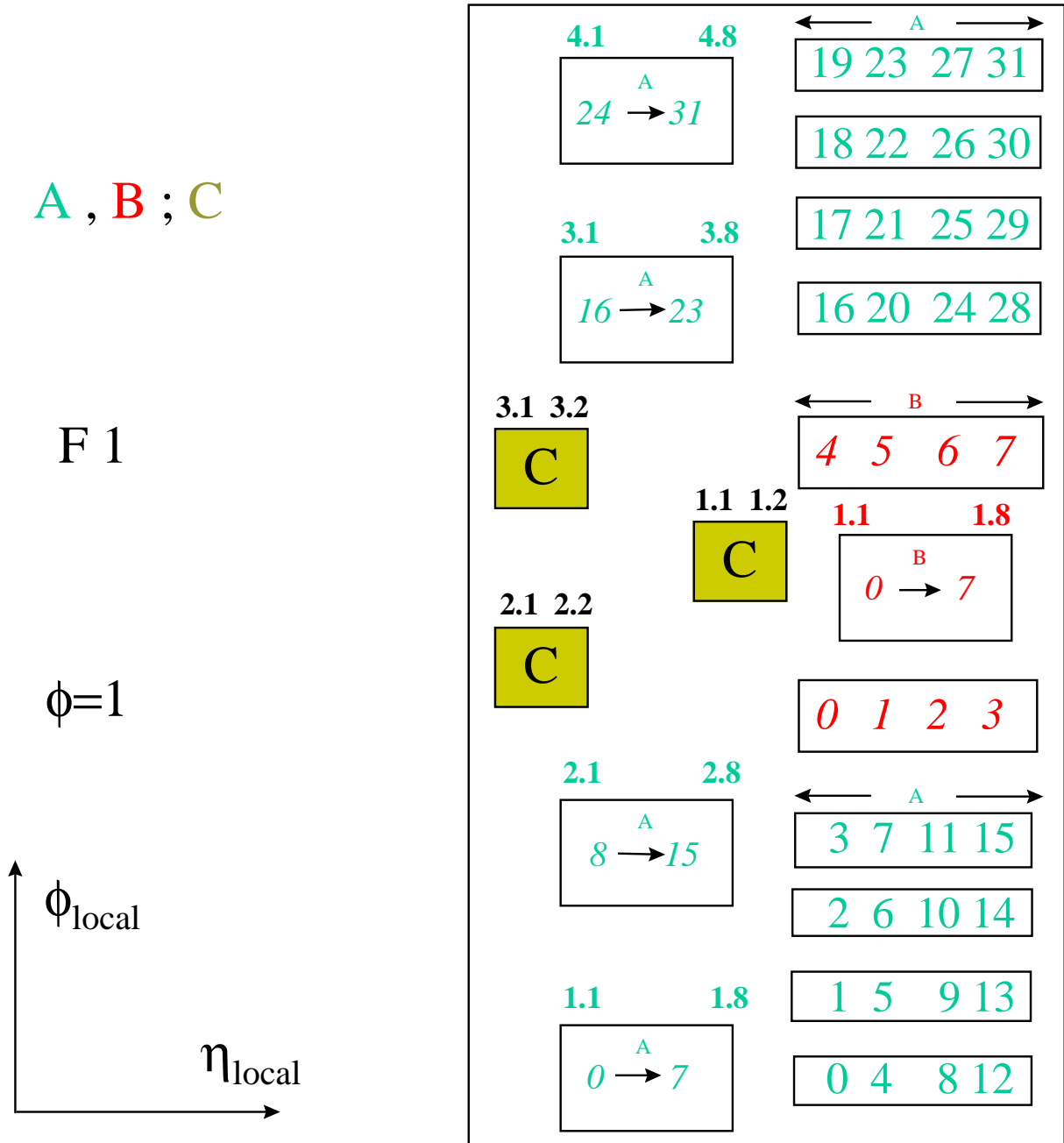

Figure 9: EMEC Front mother boards for the region $1.375 < \eta < 1.5$.

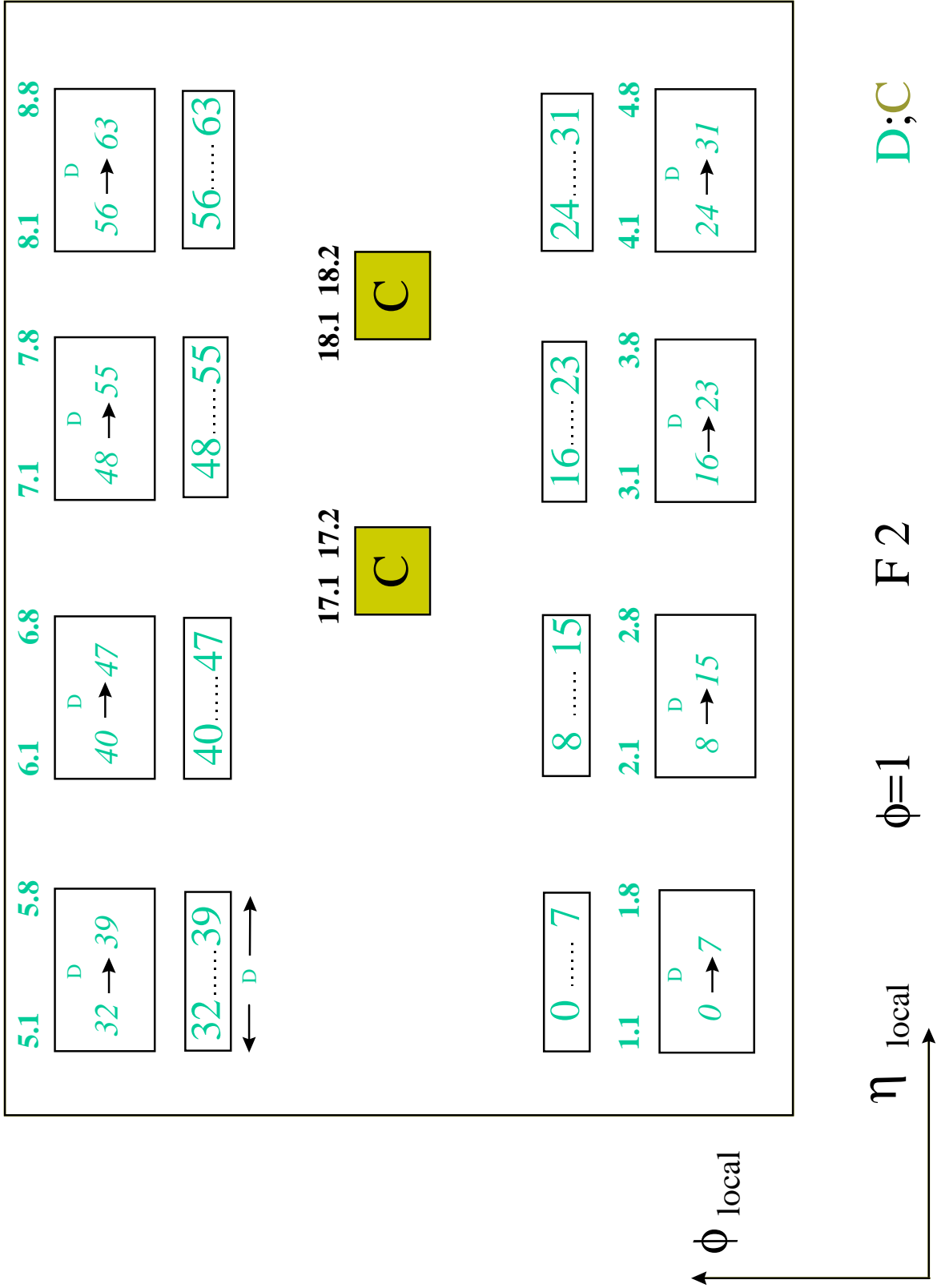

Figure 10: EMEC Front mother boards for the region $1.5 < \eta < 1.6$.

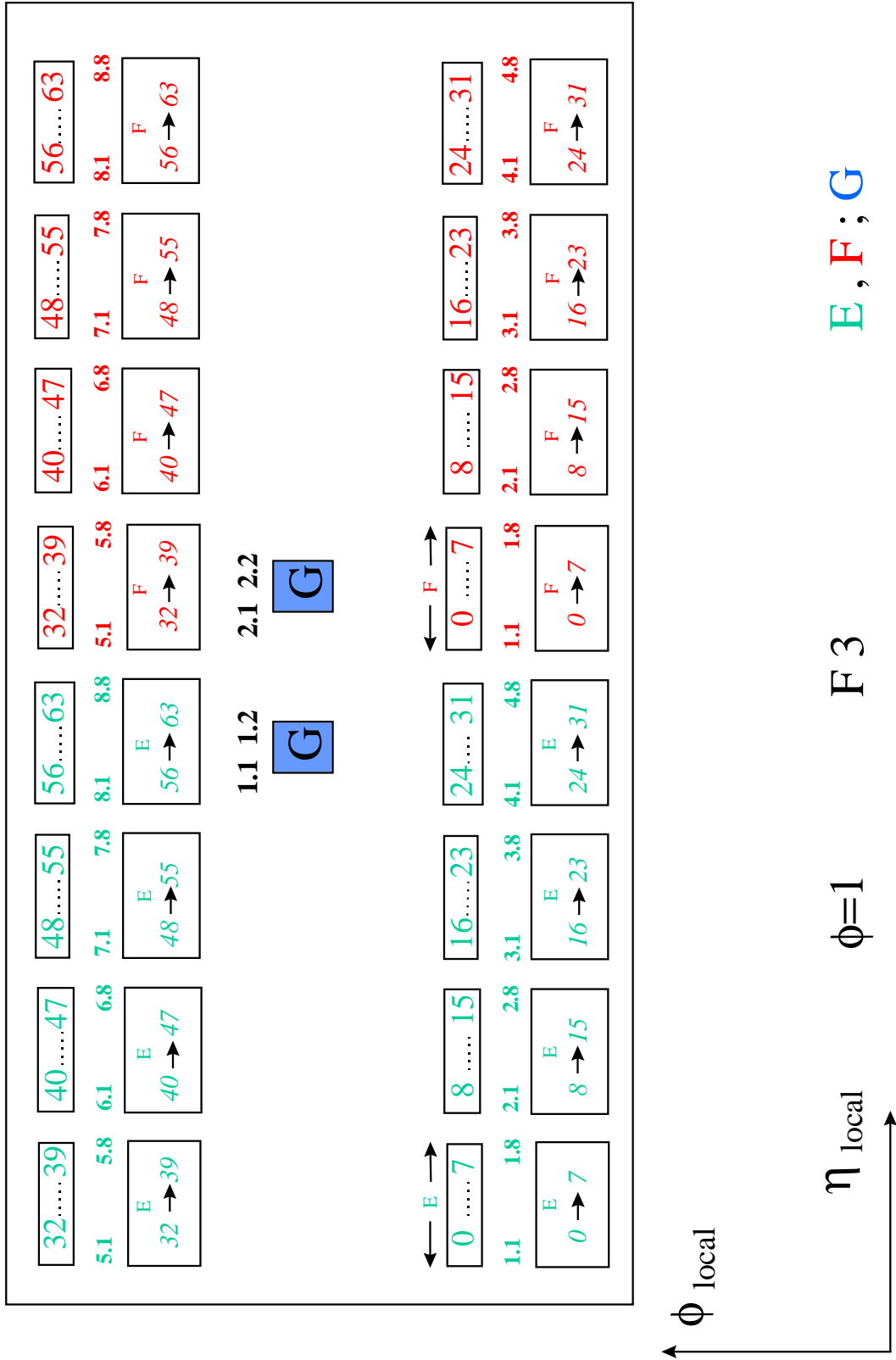

Figure 11: EMEC Front mother boards for the region $1.6 < \eta < 1.8$.

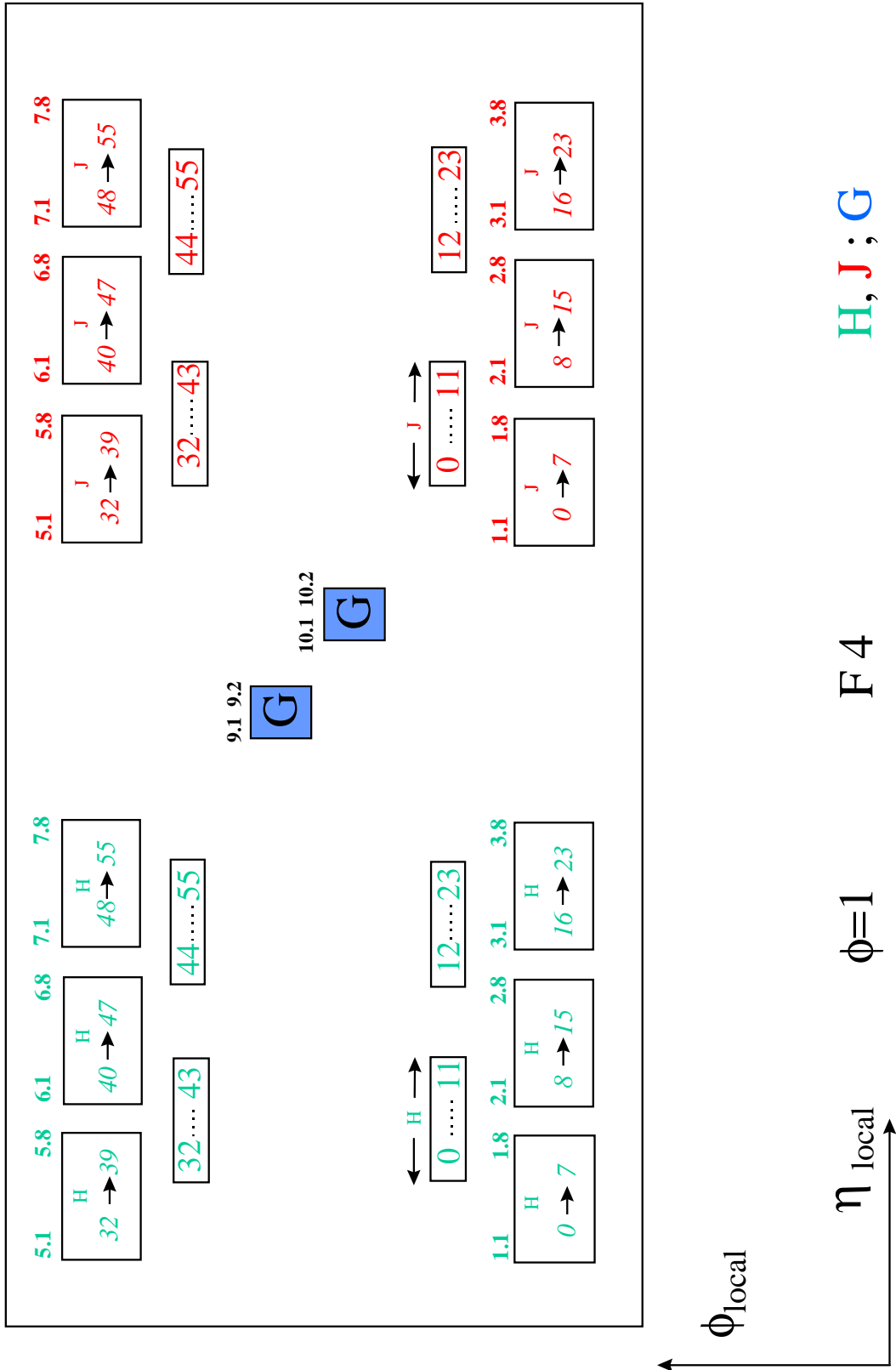

Figure 12: EMEC Front mother boards for the region $1.8 < \eta < 2.0$.

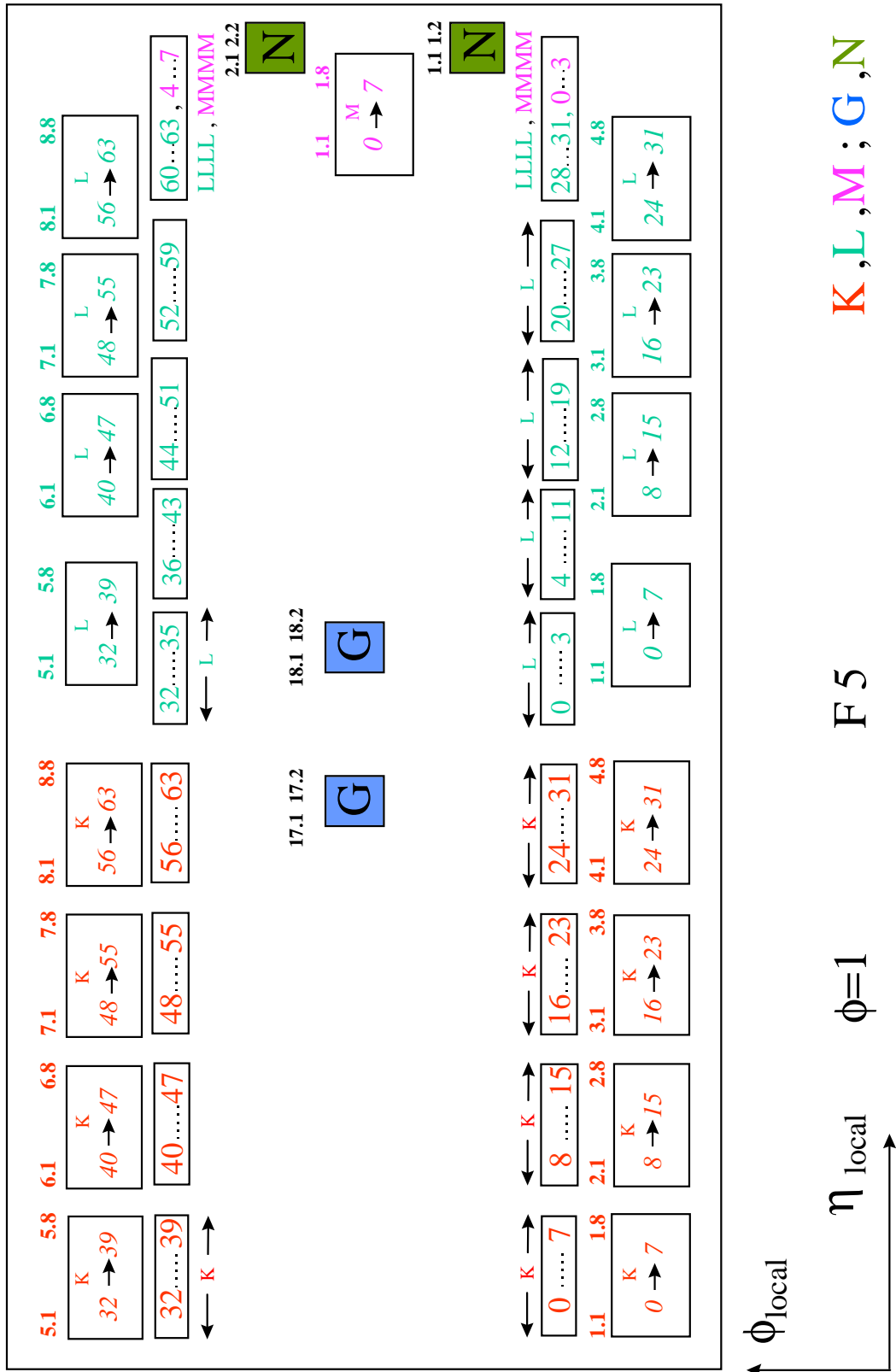

Figure 13: EMEC Front mother boards for the region $2.0 < \eta < 2.5$.

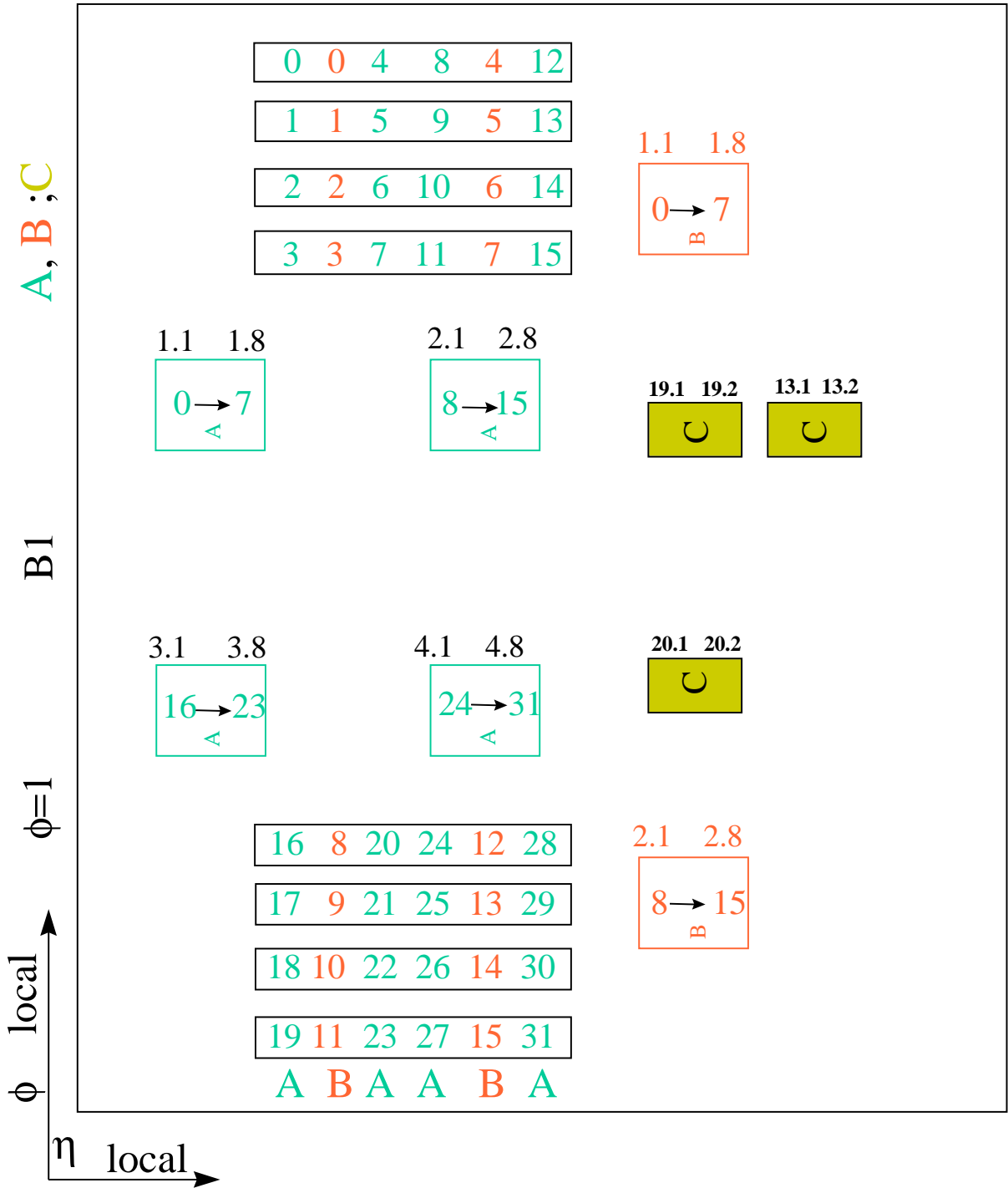

Figure 14: EMEC Back mother boards for the region $1.5 < \eta < 1.6$.

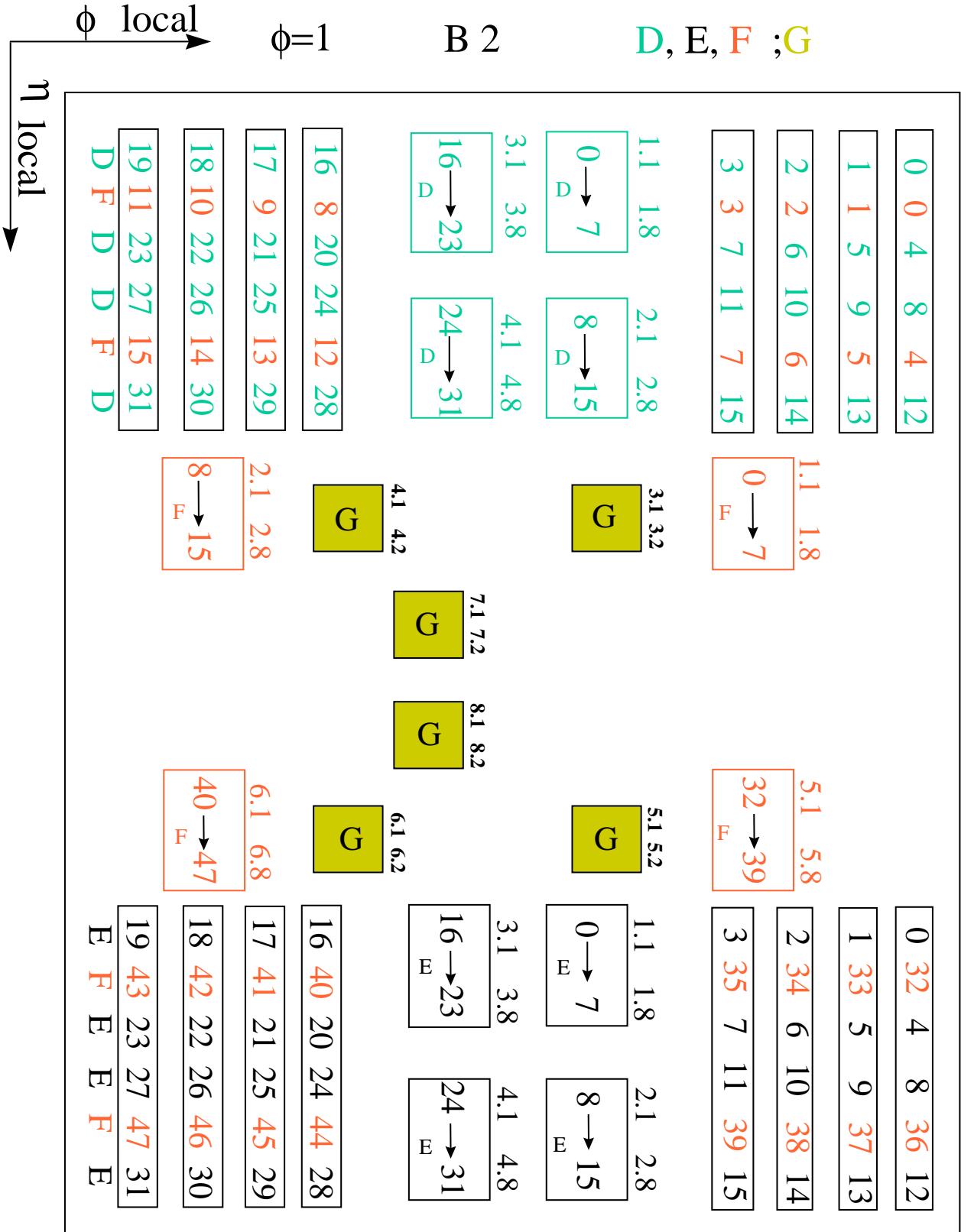

Figure 15: EMEC Back mother boards for the region $1.6 < \eta < 1.8$.

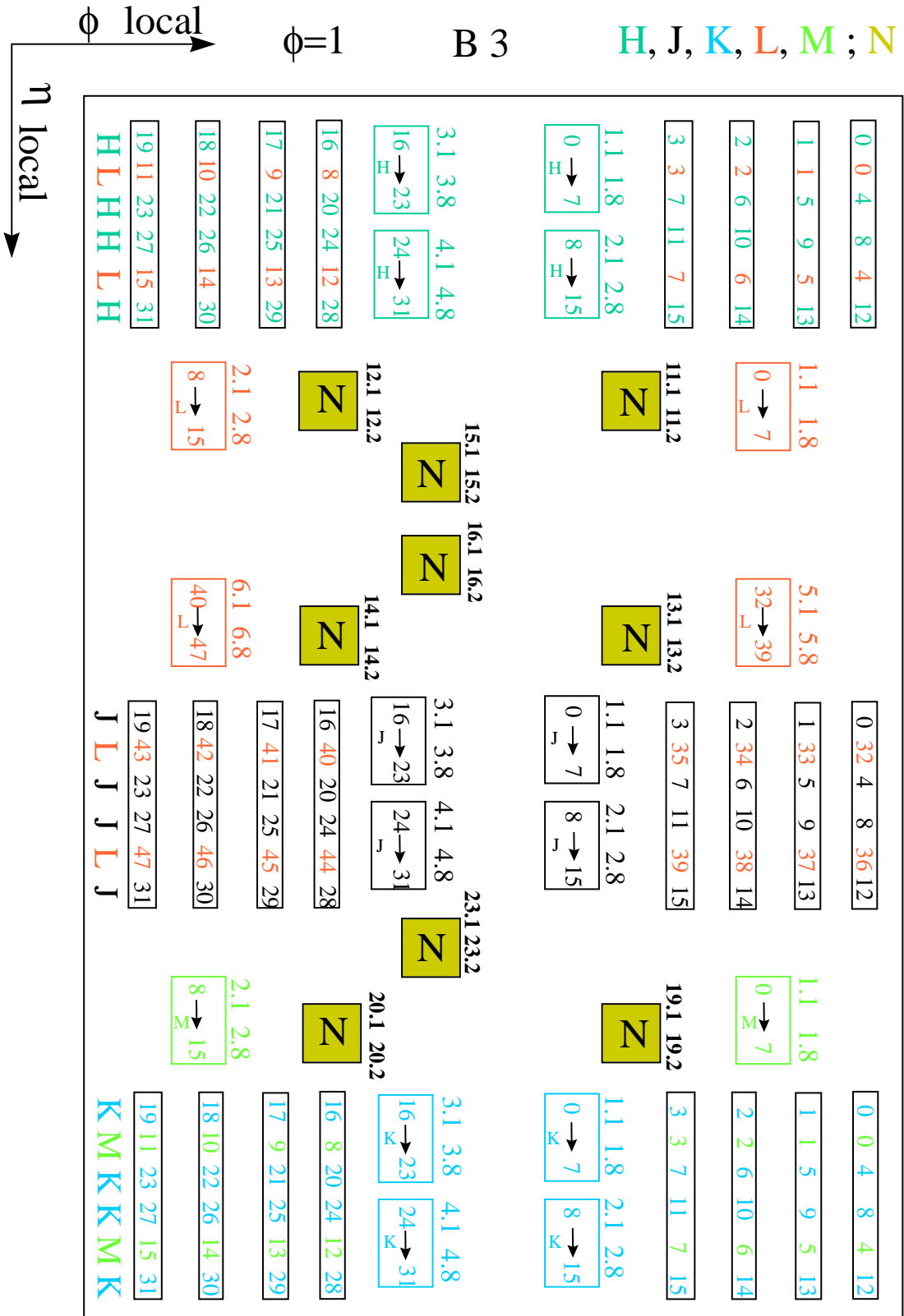

Figure 16: EMEC Back mother boards for the region $1.8 < \eta < 2.1$.

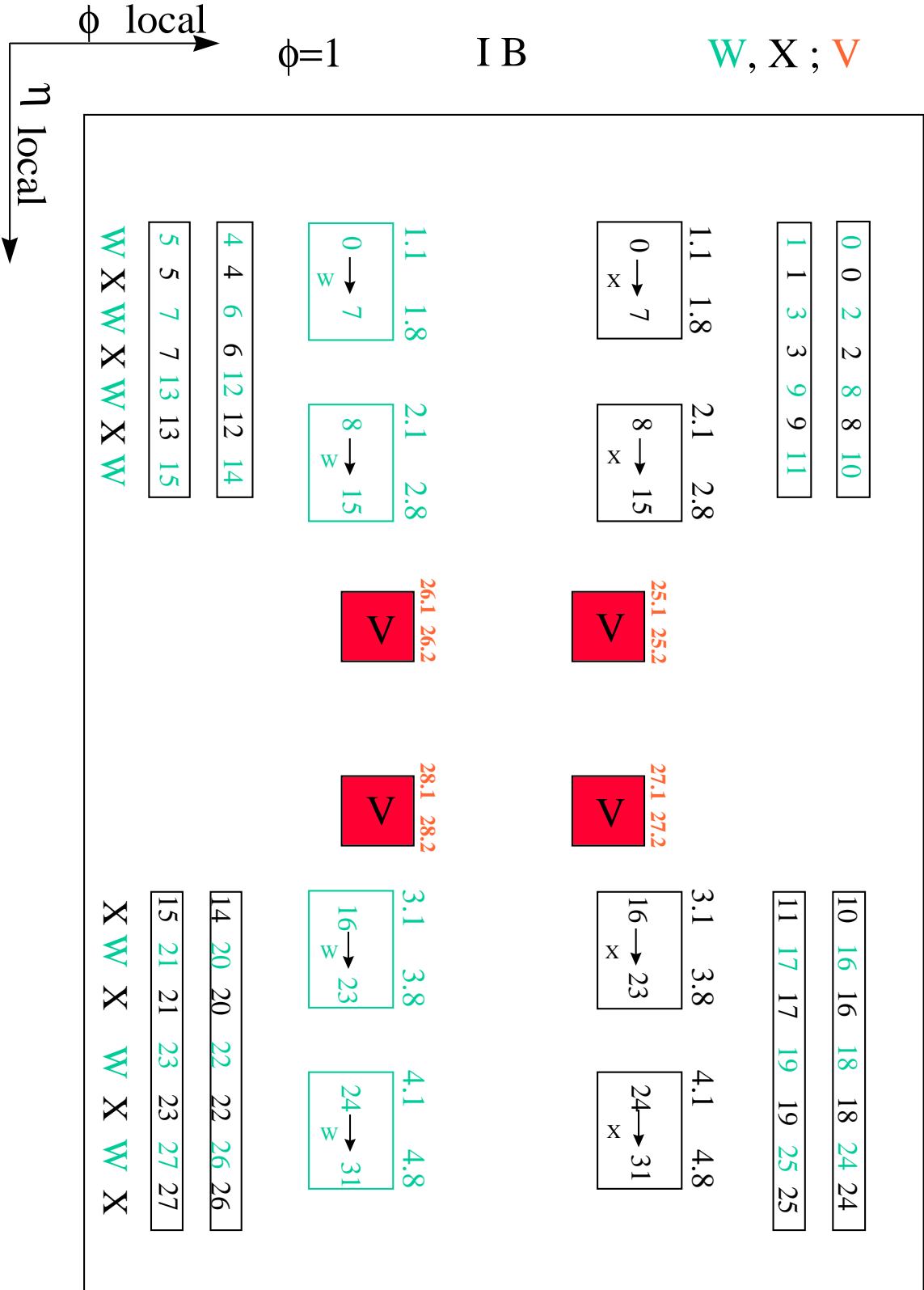

Figure 18: EMEC Back mother boards for the region $2.5 < \eta < 3.2$.

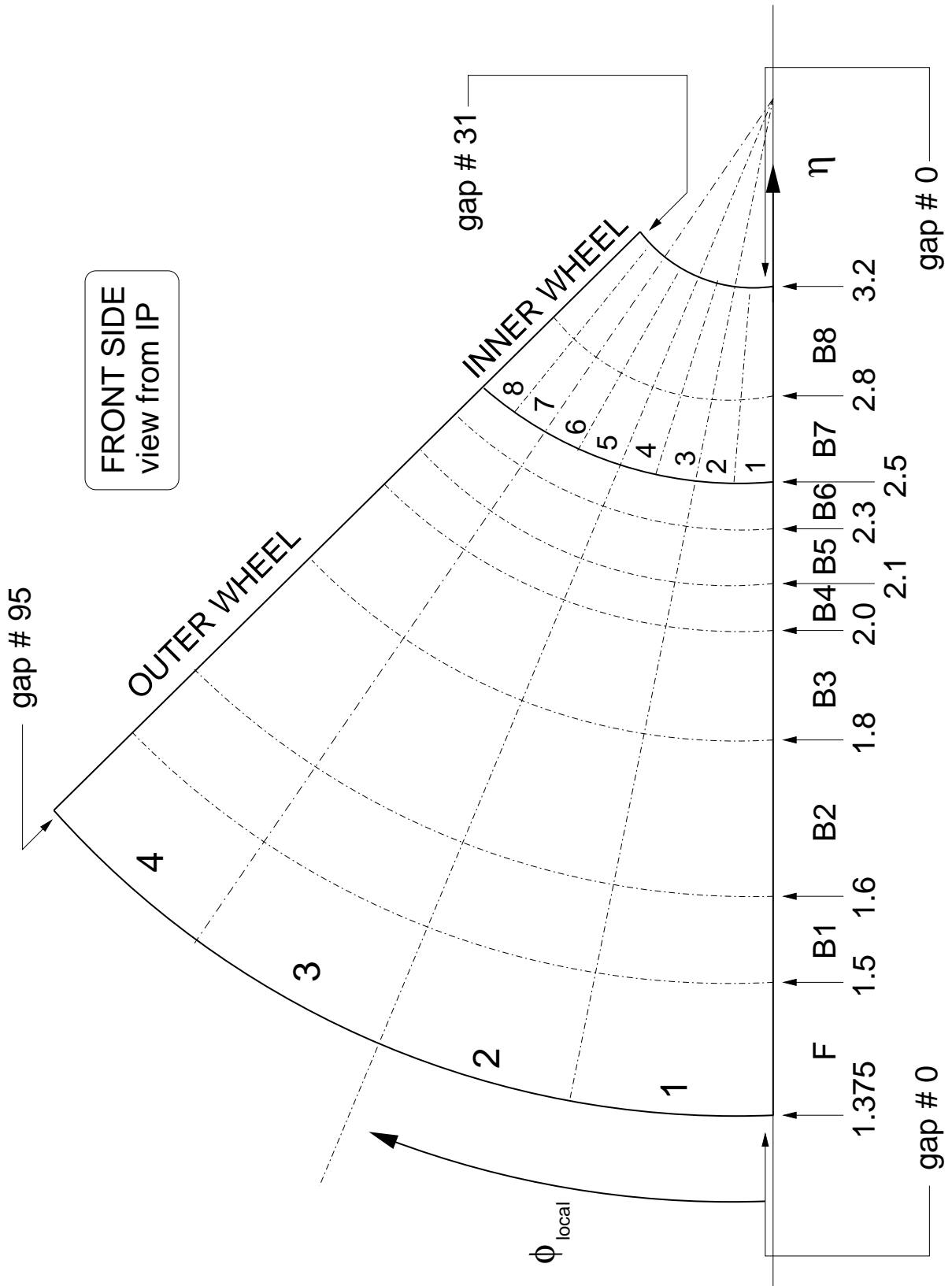

Figure 19: Schematic view of the high voltage zone for an EMEC module locking from the interaction point.

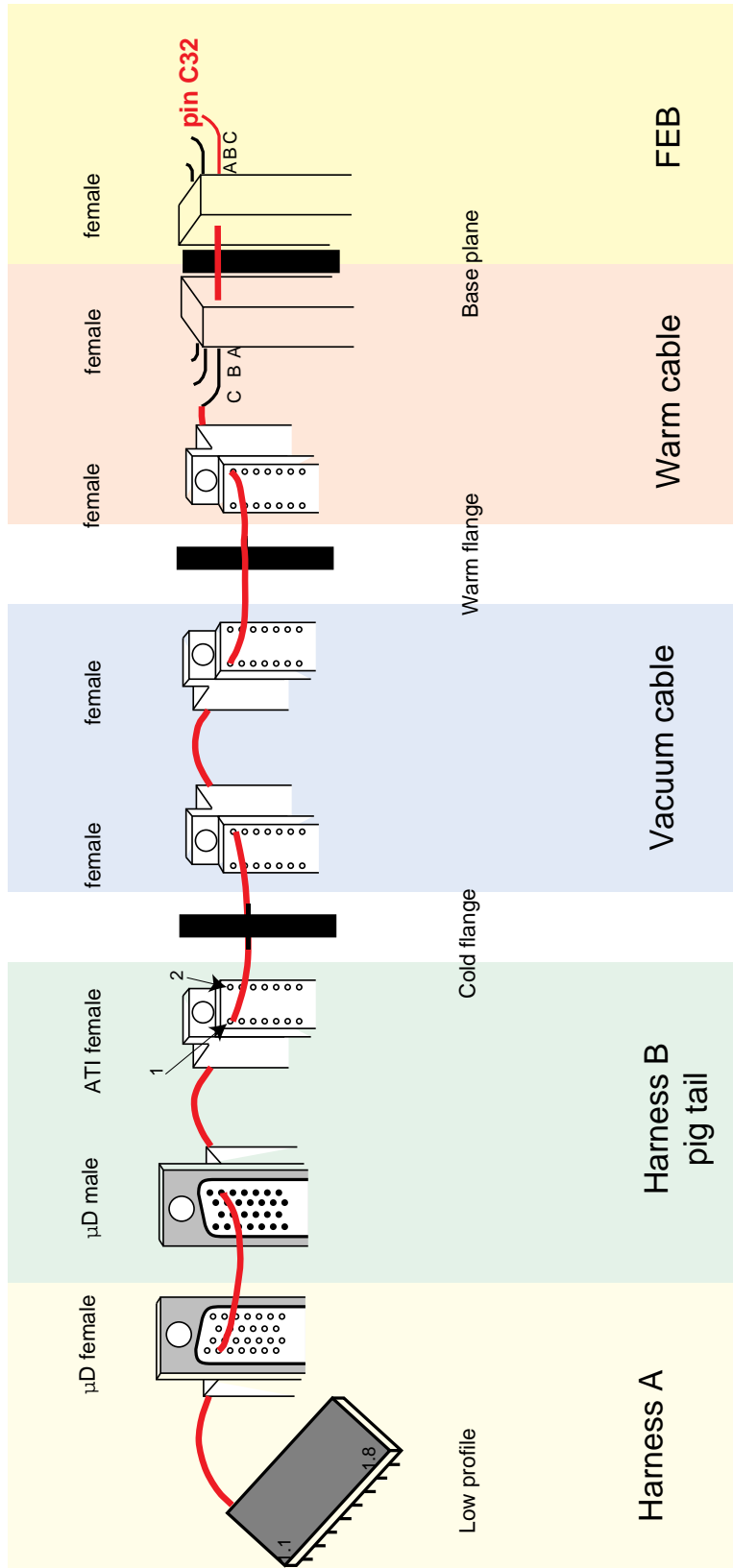
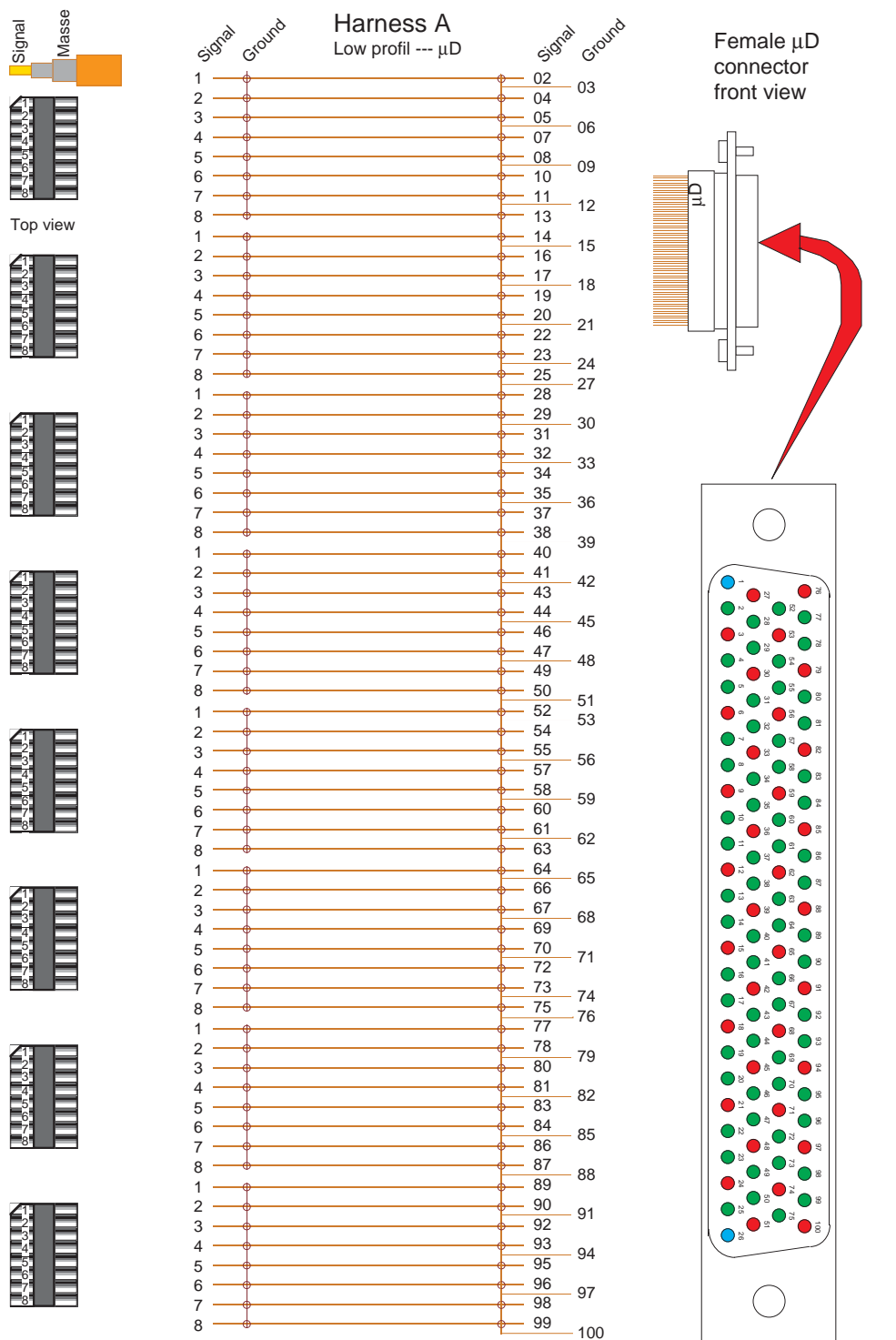
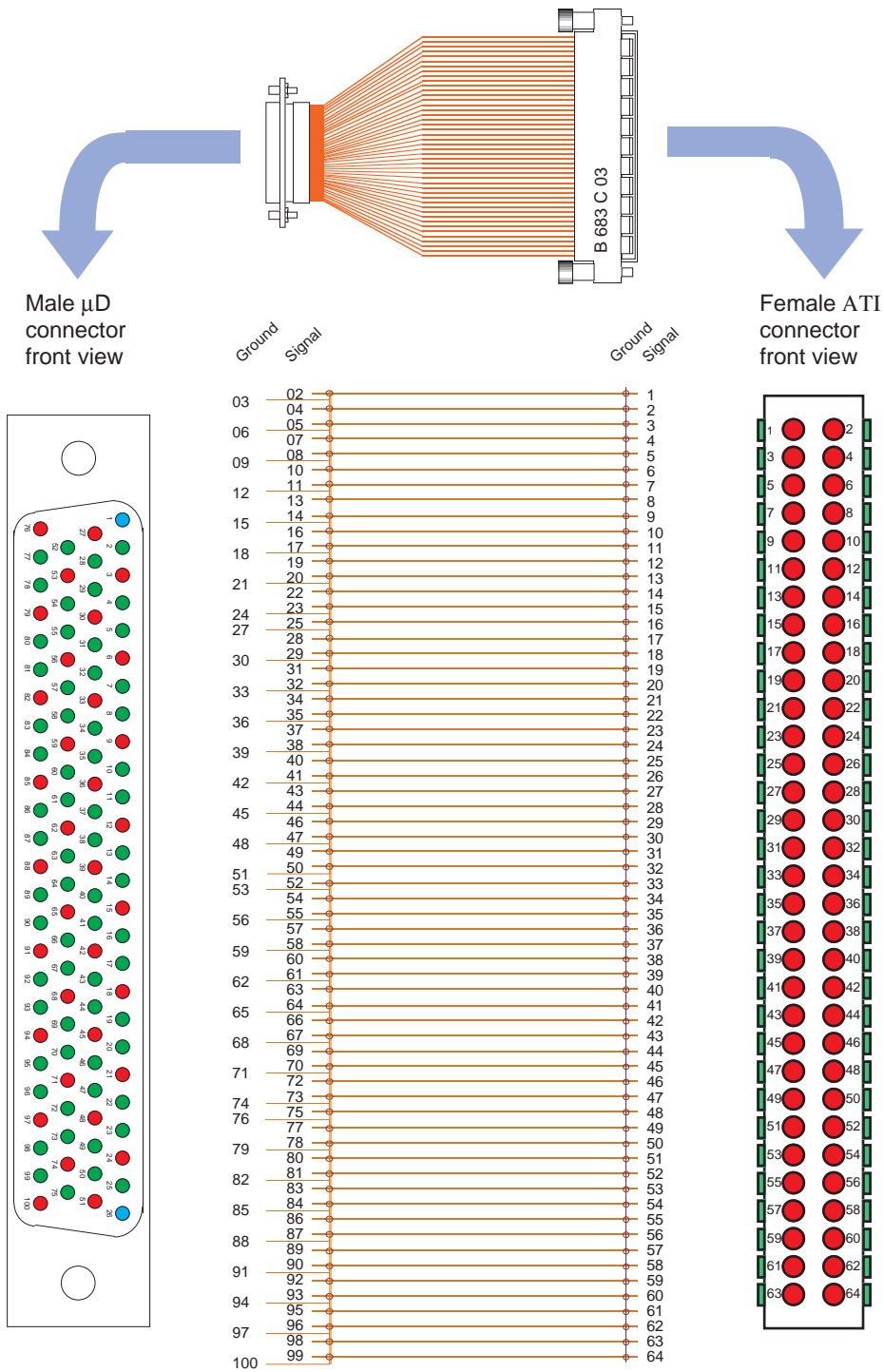

Figure 20: Electrical connections from the mother board to the front-end board.



PC L.A.L. ORSAY 26/05/1997

Figure 21: Harness A (goes between a mother-board and the module patch panel).



PC L.A.L ORSAY 26/05/1997

Figure 22: Harness B or pig-tail (goes between the module patch panel and the feedthrough cold flange).

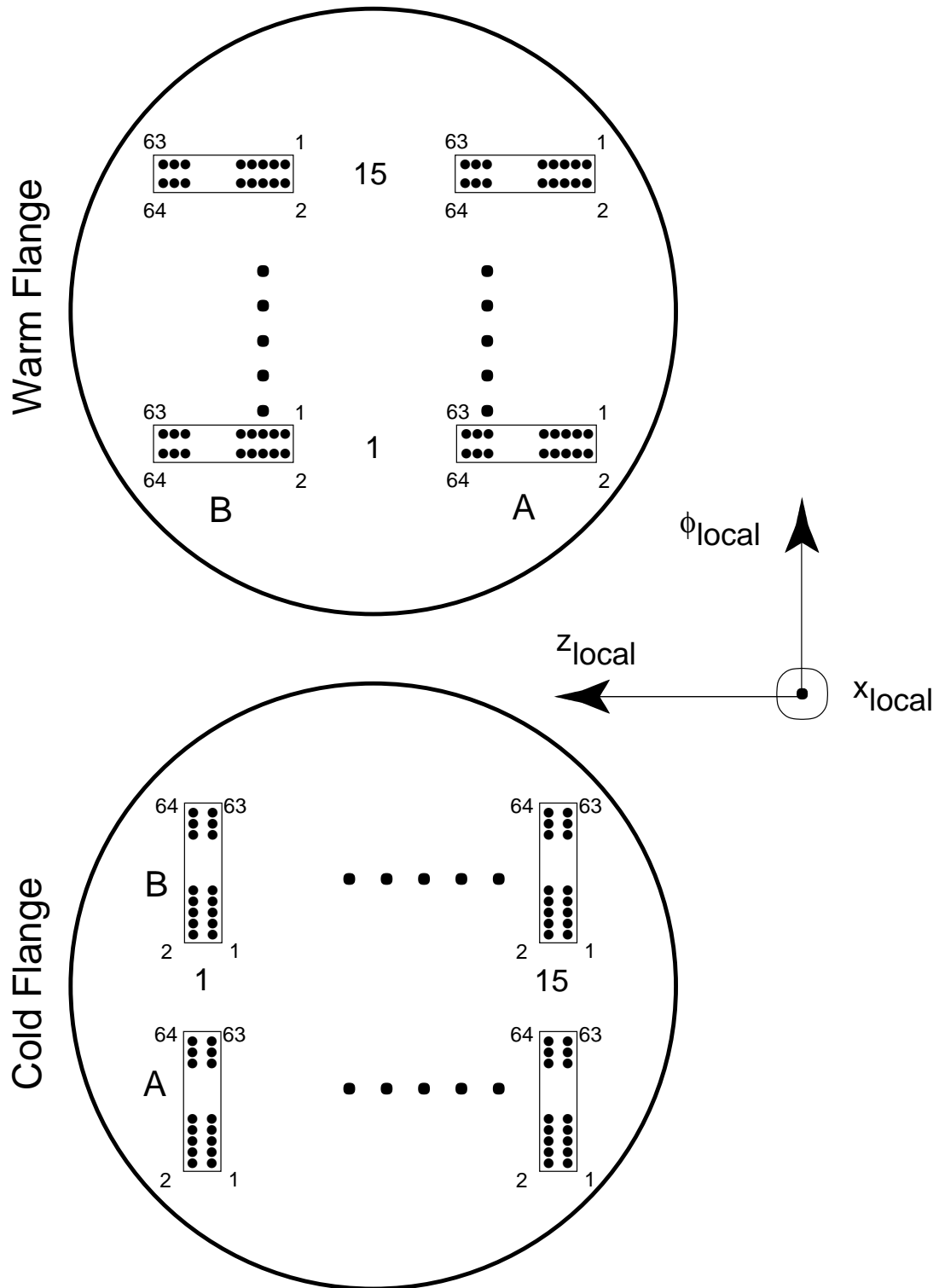

Figure 23: Connection to the feedthrough flanges. Pin number refers to signal line number as defined in the text. Note the definition of the connector numbering on the flange from 1A to 15B. Note also the direction of the rotation between the cold and warm flanges.

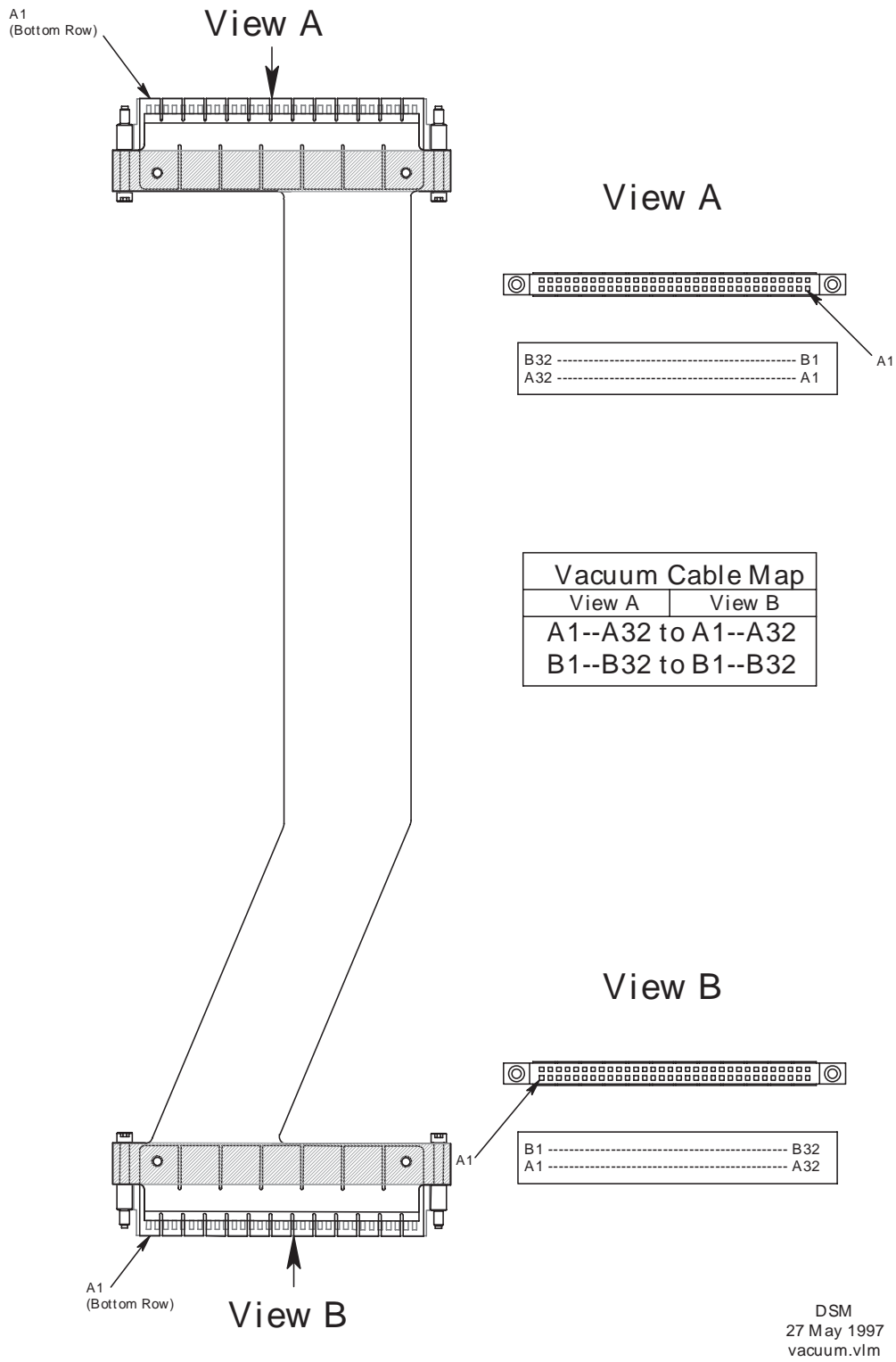

Figure 24: Vacuum cable between the cold and warm flanges of the feedthroughs.

Warm Cable

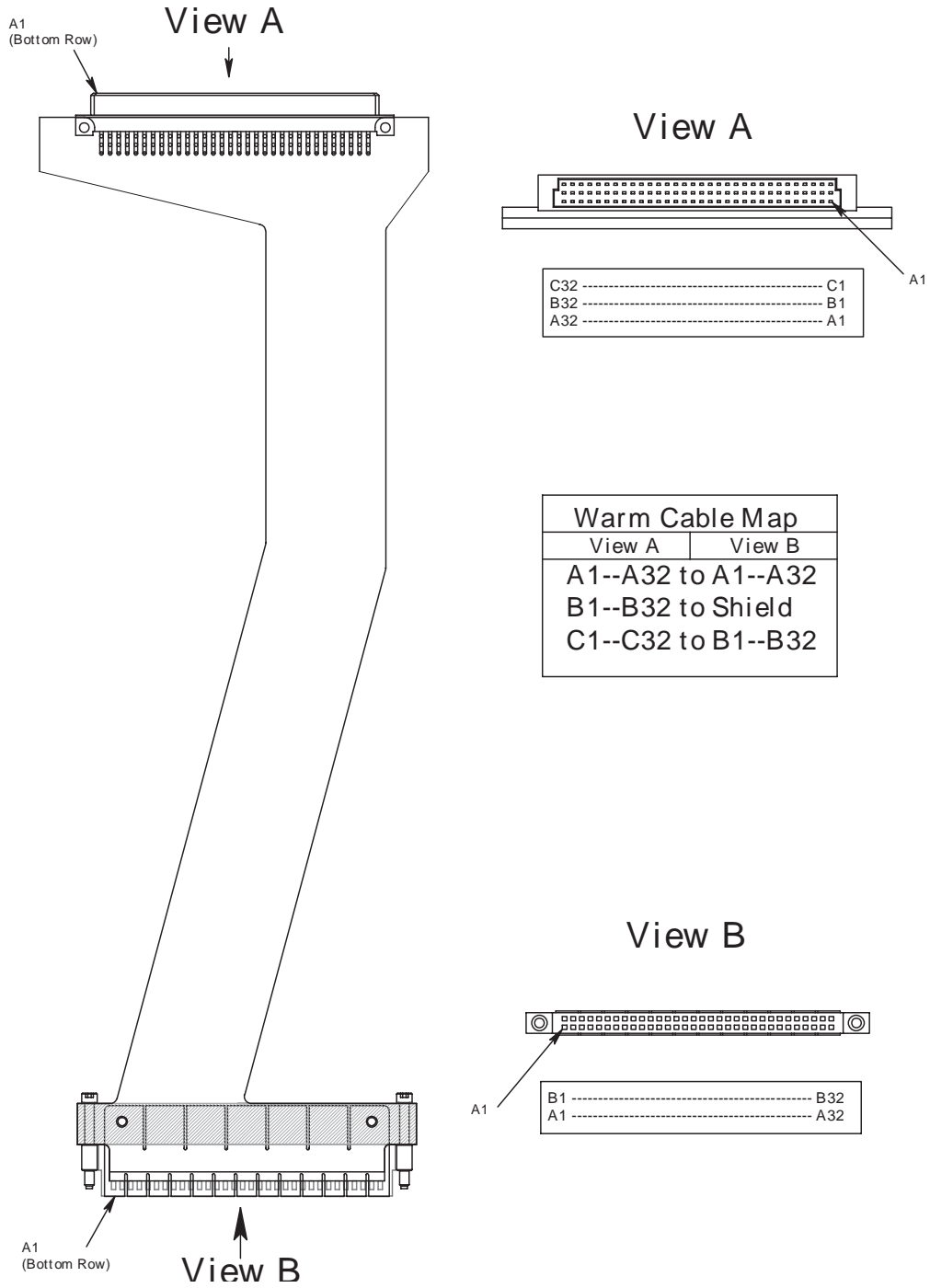

Figure 25: Warm cable in the pedestal between the warm flange and the crate base-plane.

Warm Flange to FEB Connection

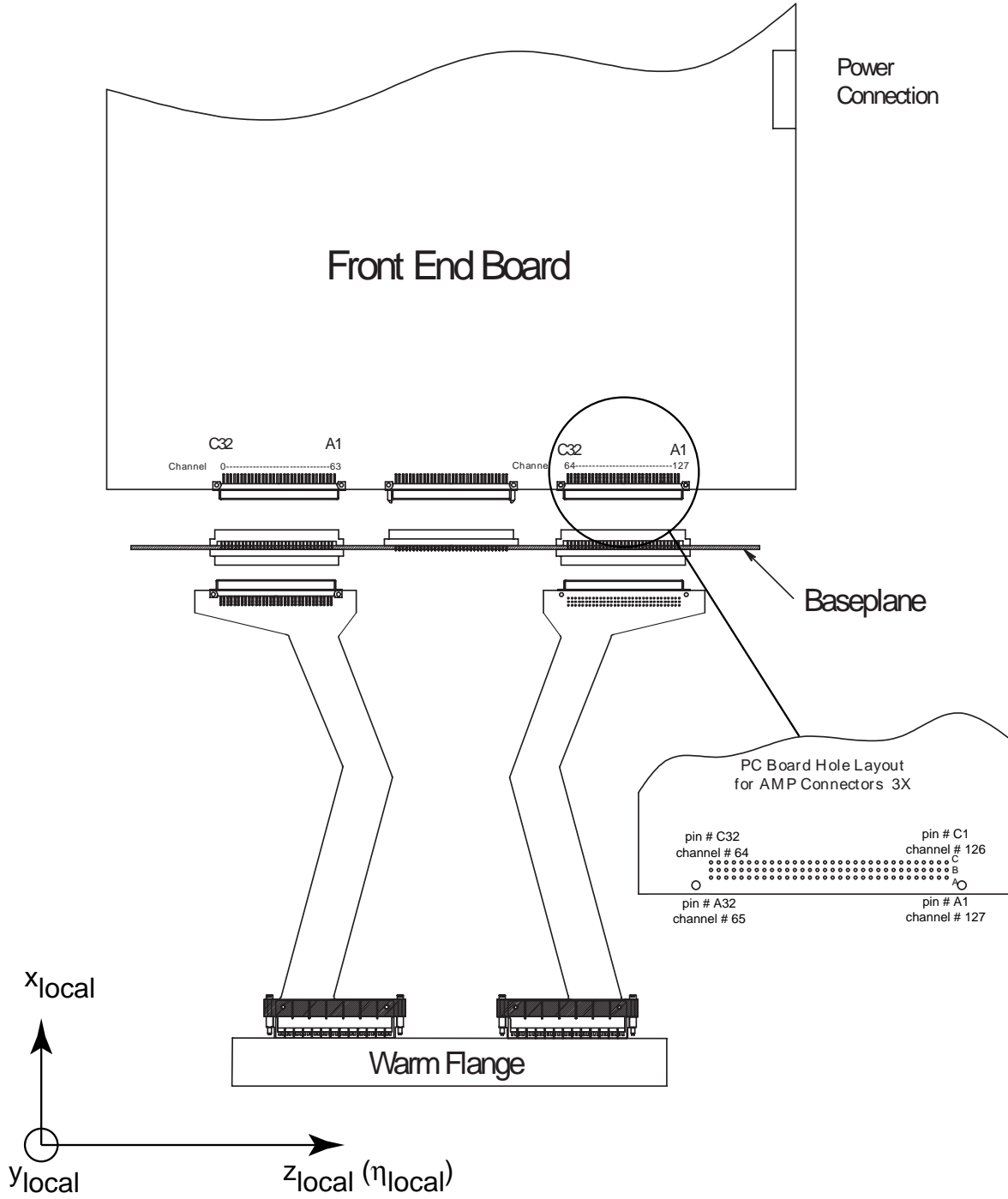

Figure 26: Warm cable in the pedestal between the warm flange and the crate base-plane.

EMB SIGNAL MAPPING

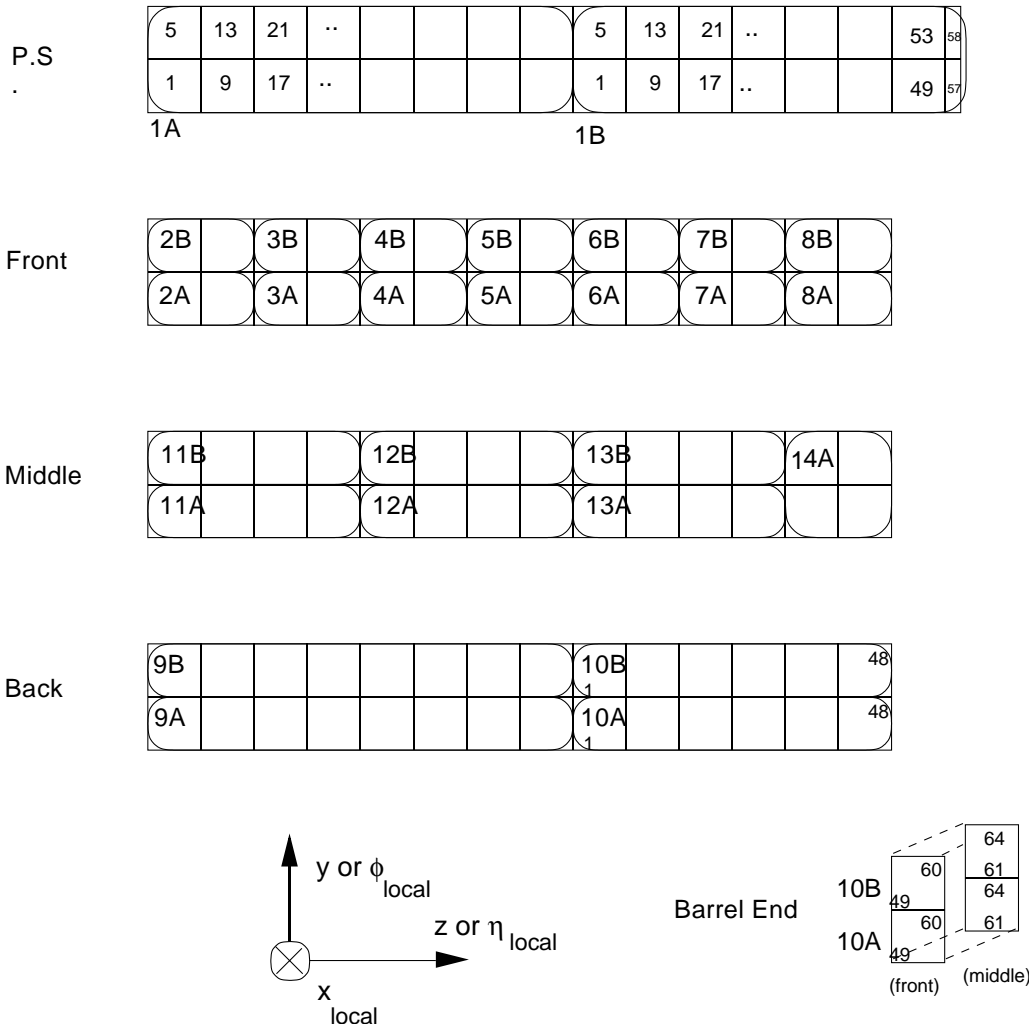

Figure 27: Mapping of each layer of the barrel EM on feedthrough connectors. Each square represents a trigger tower. Groups of trigger towers sharing a common feedthrough connector (bold line) are labelled by the connector number. Within a connector, towers are cabled first by increasing ϕ then by increasing η .

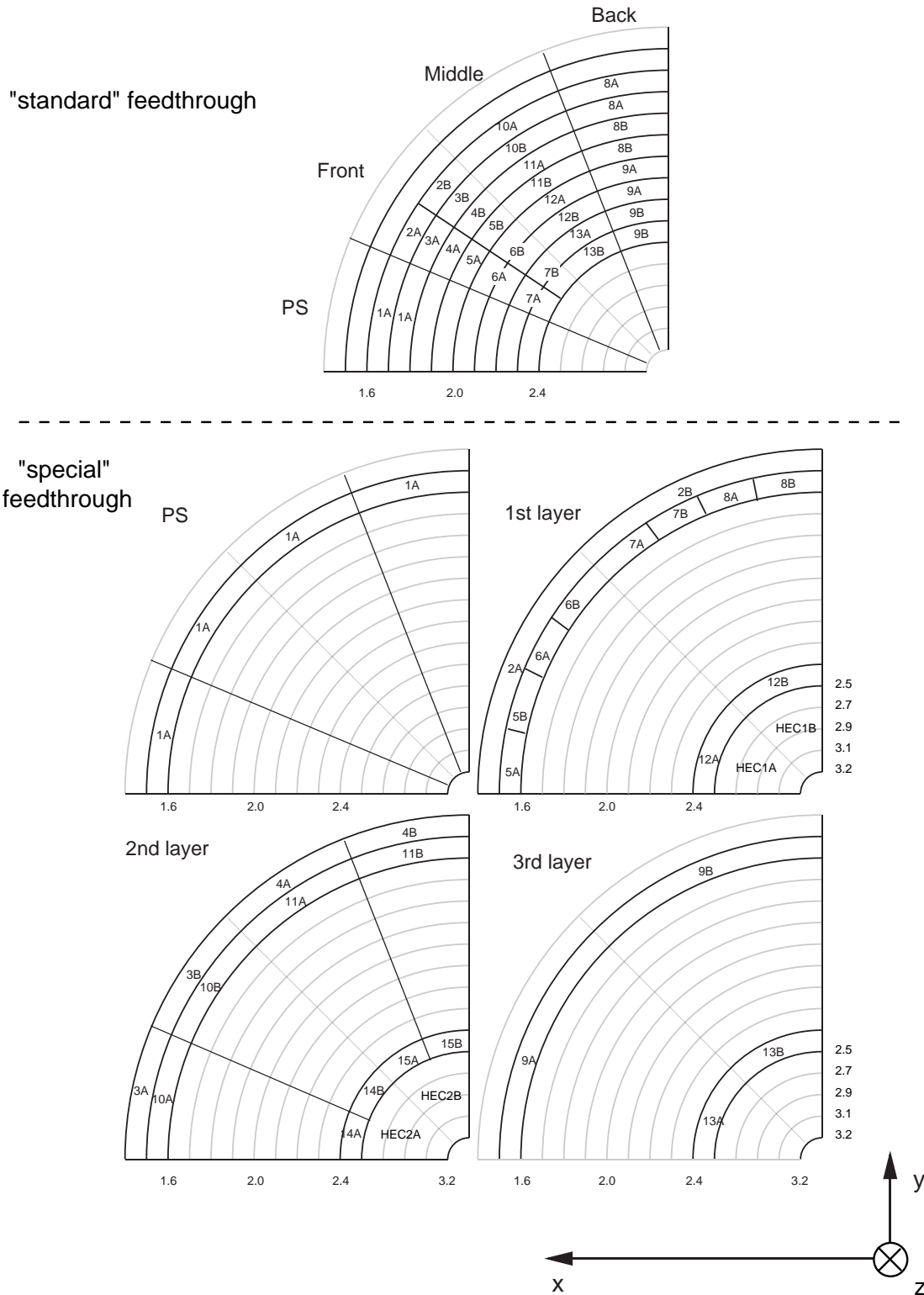

Figure 28: Mapping of each layer of the end-cap EM on feedthrough connectors. Groups of trigger towers sharing a common feedthrough connector are labelled by the connector number. Within a connector, towers are cabled first by increasing ϕ then by increasing η . Note that the “distance” between lines is not constant in rapidity ($\Delta\eta = .1$ for $\eta < 2.5$ and $.2$ for $2.5 < \eta < 3.1$).

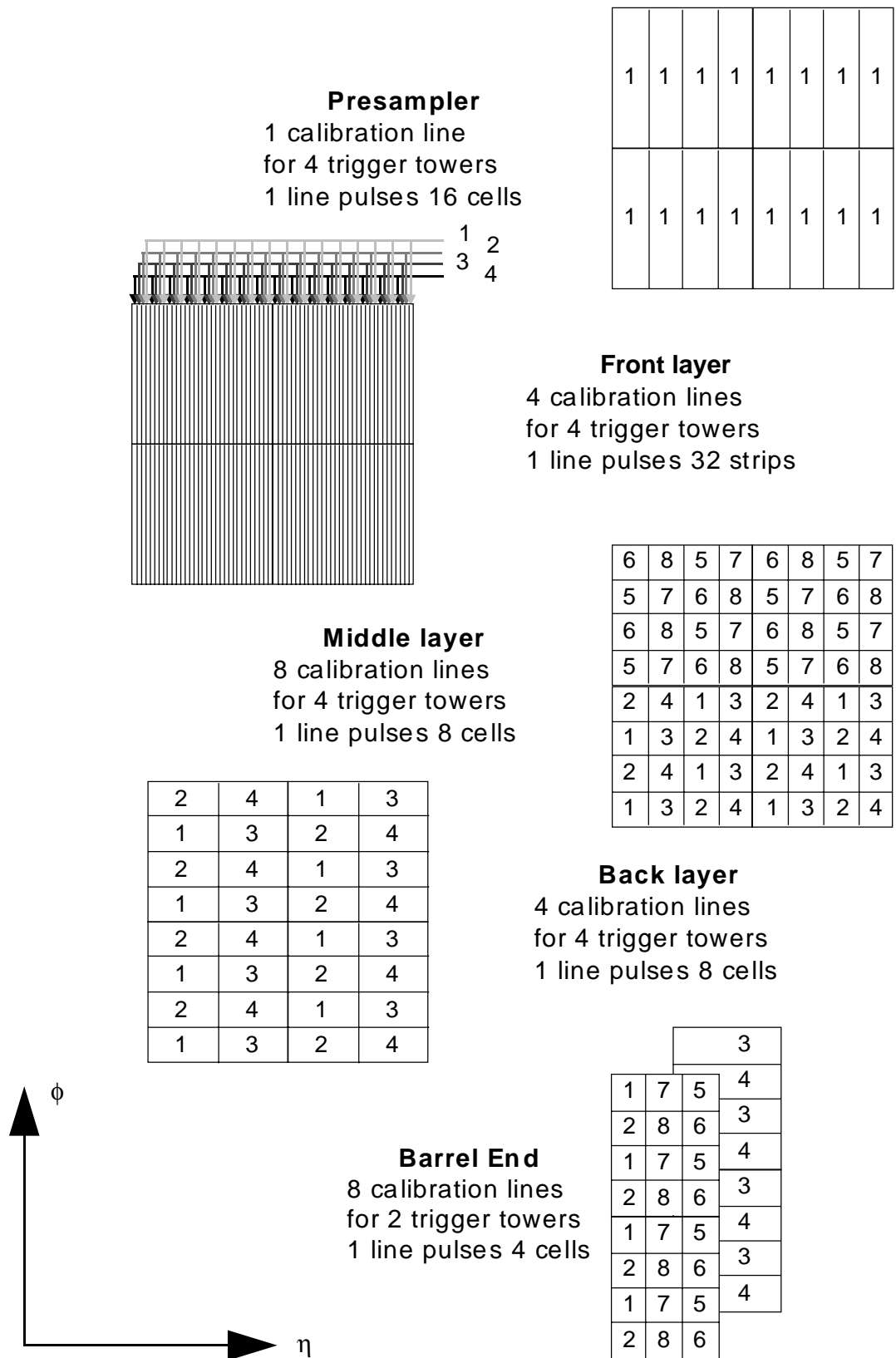

Figure 29: Symbolic representation of the calibration pattern in the EM barrel. The number within a cell gives the calibration line number relative to this group of cells (the calibration line number starts from 1). Cells with identical calibration line numbers are pulsed simultaneously.

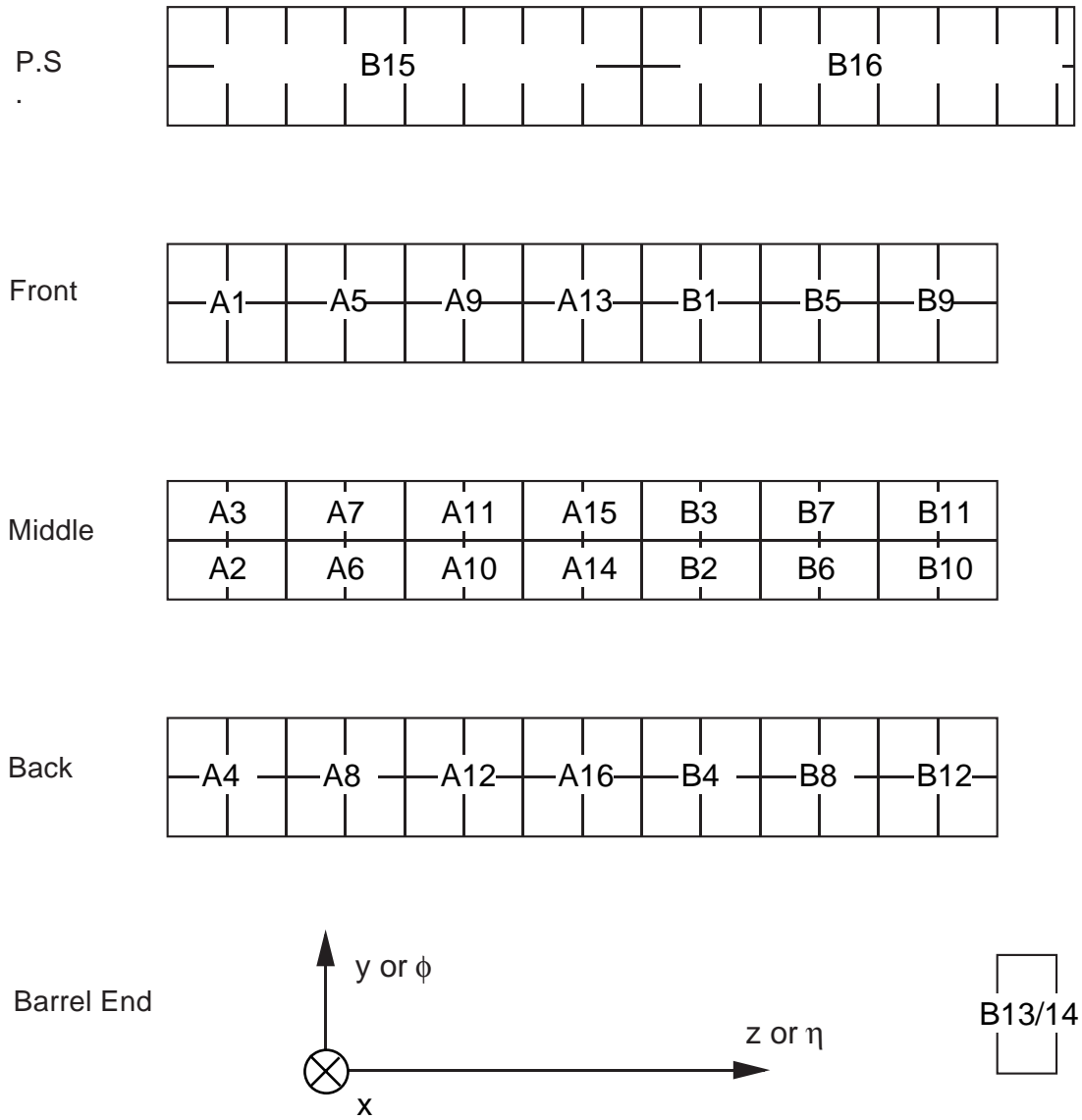

Figure 30: One calibration board with two 64 lines harnesses (A and B) pulses an half barrel azimuthal slice of $\Delta\phi = 0.2$. Each harness ends in 16 low profile connectors numbered 1 to 16. This figure where each little square represents a trigger tower, sketches the cabling of these connectors on the barrel calorimeter.

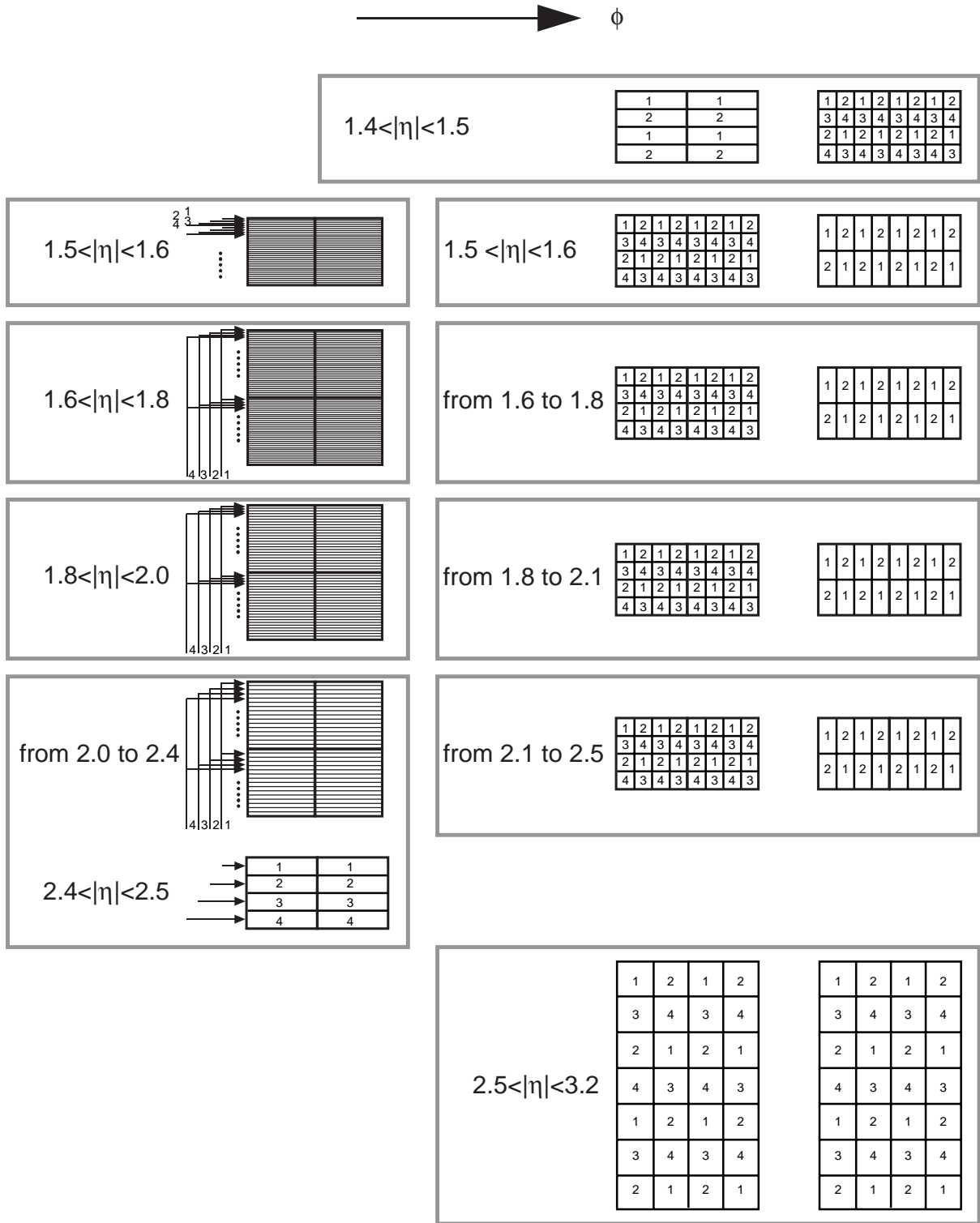

Figure 31: Symbolic representation of the calibration pattern in the EM end-cap. The number within a cell gives the calibration line number relative to this group of cells. Within a layer, cells with identical calibration line # are pulsed simultaneously. Each cross-hatched box represents a mother board.

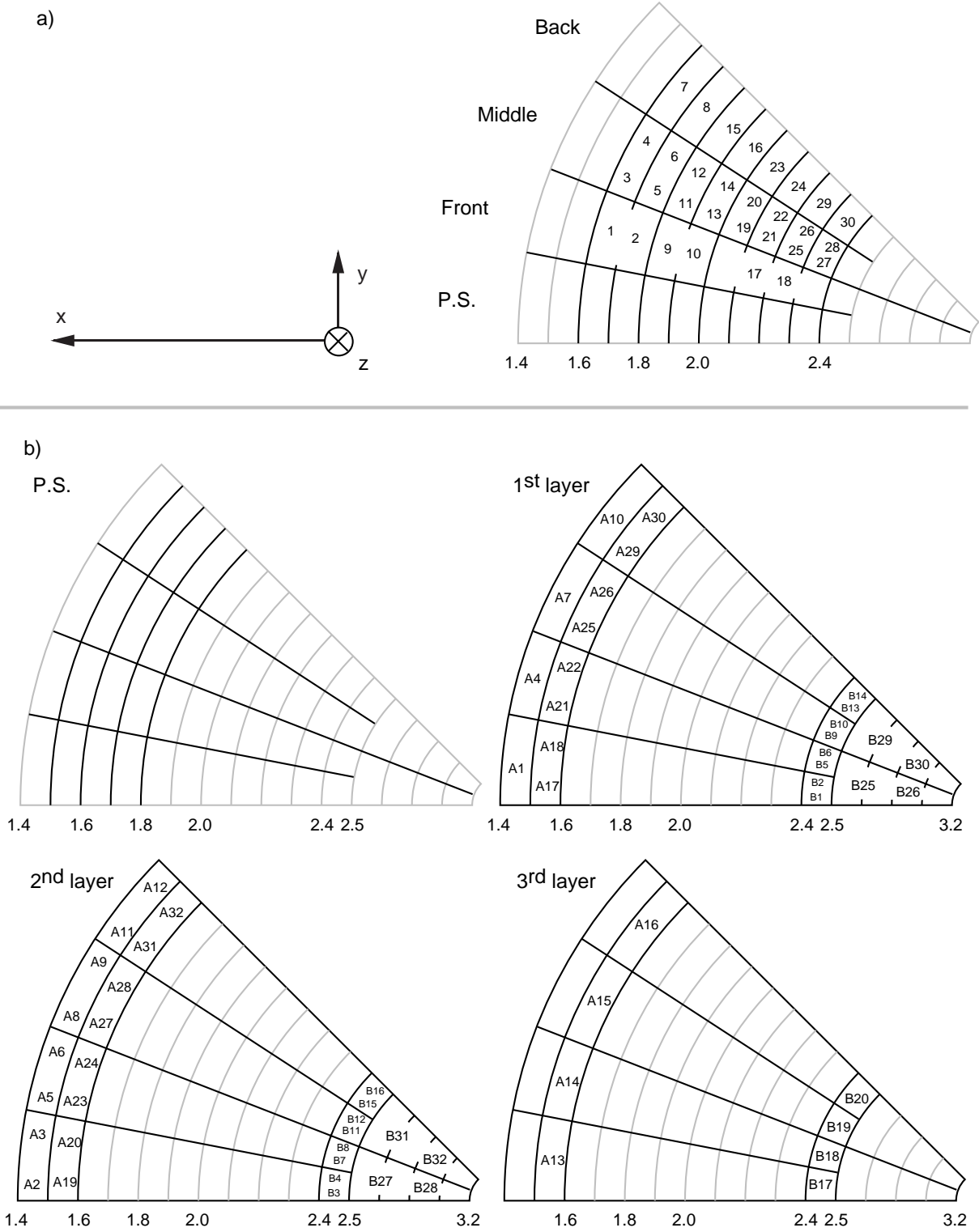

Figure 32: Schematic representation of an EM end-cap wedge ($\Delta\phi = 0.8$). Concentric lines are drawn at trigger tower boundaries. Calibration harnesses end in 32 low profile connectors numbered 1 to 32. a) Two calibration boards (i.e. 4 calibration harnesses) pulse the “standard” region. The first harness is cabled to the region $0 < \phi < 0.2$, the second to $0.2 < \phi < .4$ and so on. Otherwise their cabling is identical and defined by a). b) One calibration board pulse the “special” region of an EM end-cap wedge: $\Delta\phi = 0.8$. The cabling to the detector is defined by b).

BARREL FEEDTHROUGH WARM FLANGE (seen from the warm side)

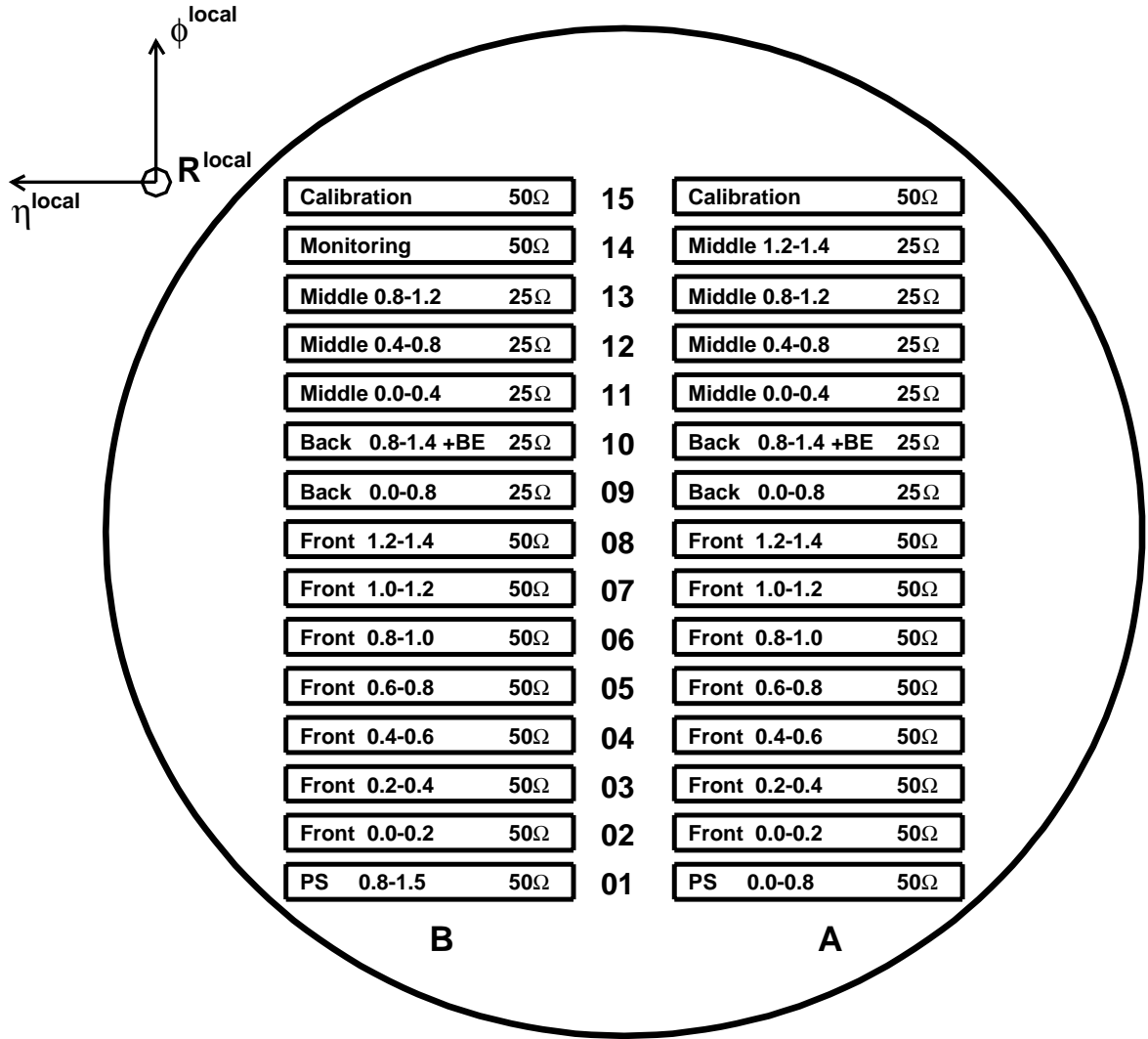

Figure 33: Map of the warm flange seen from the warm side for the EM barrel calorimeter. The cable impedance (50 or 25Ω) together with a calorimeter zone or a function is indicated for each connector.

ENDCAP STANDARD FEEDTHROUGH WARM FLANGE

(seen from the warm side)

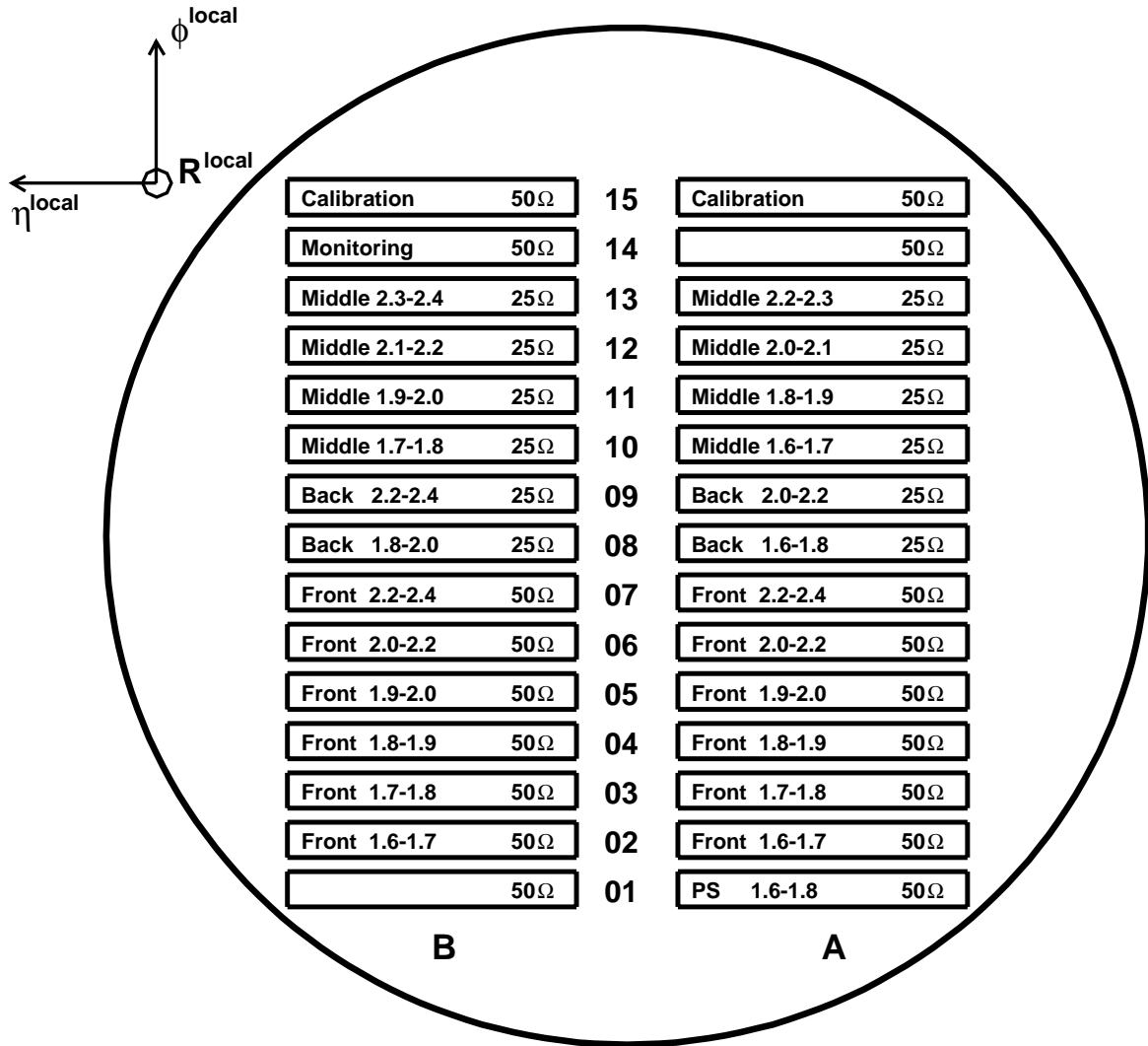

Figure 34: Map of the cold flange seen from liquid argon for the “standard” feedthrough of the EM end-cap calorimeter. The cable impedance (50 or 25Ω) together with a calorimeter zone or a function is indicated for each connector.

ENDCAP SPECIAL FEEDTHROUGH WARM FLANGE

(seen from the warm side)

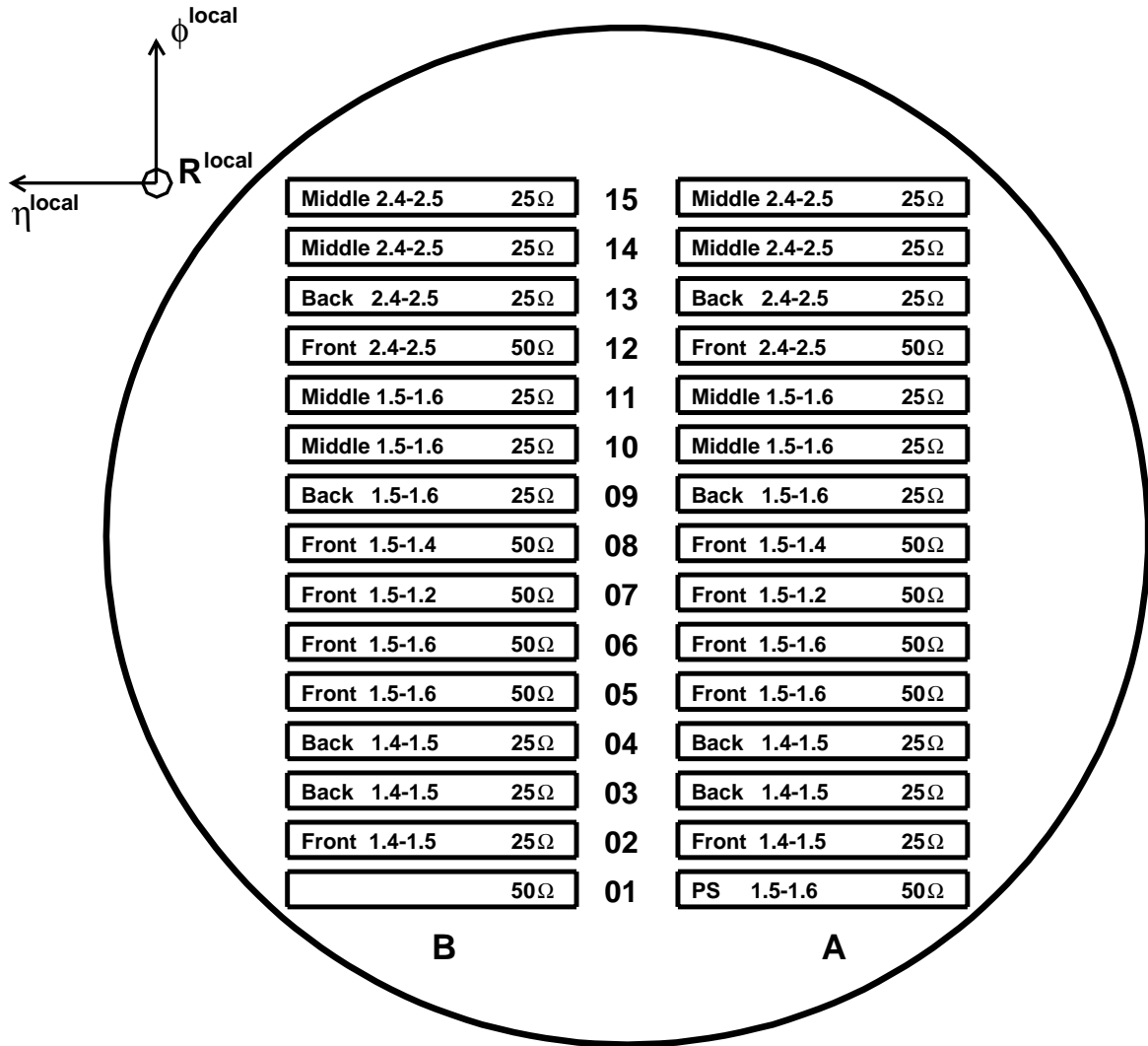

Figure 35: Map of the cold flange seen from liquid argon for the “special” feedthrough of the EM end-cap calorimeter. The cable impedance (50 or 25 Ω) together with a calorimeter zone or a function is indicated for each connector.

HEC FEEDTHROUGH WARM FLANGE (seen from the warm side)

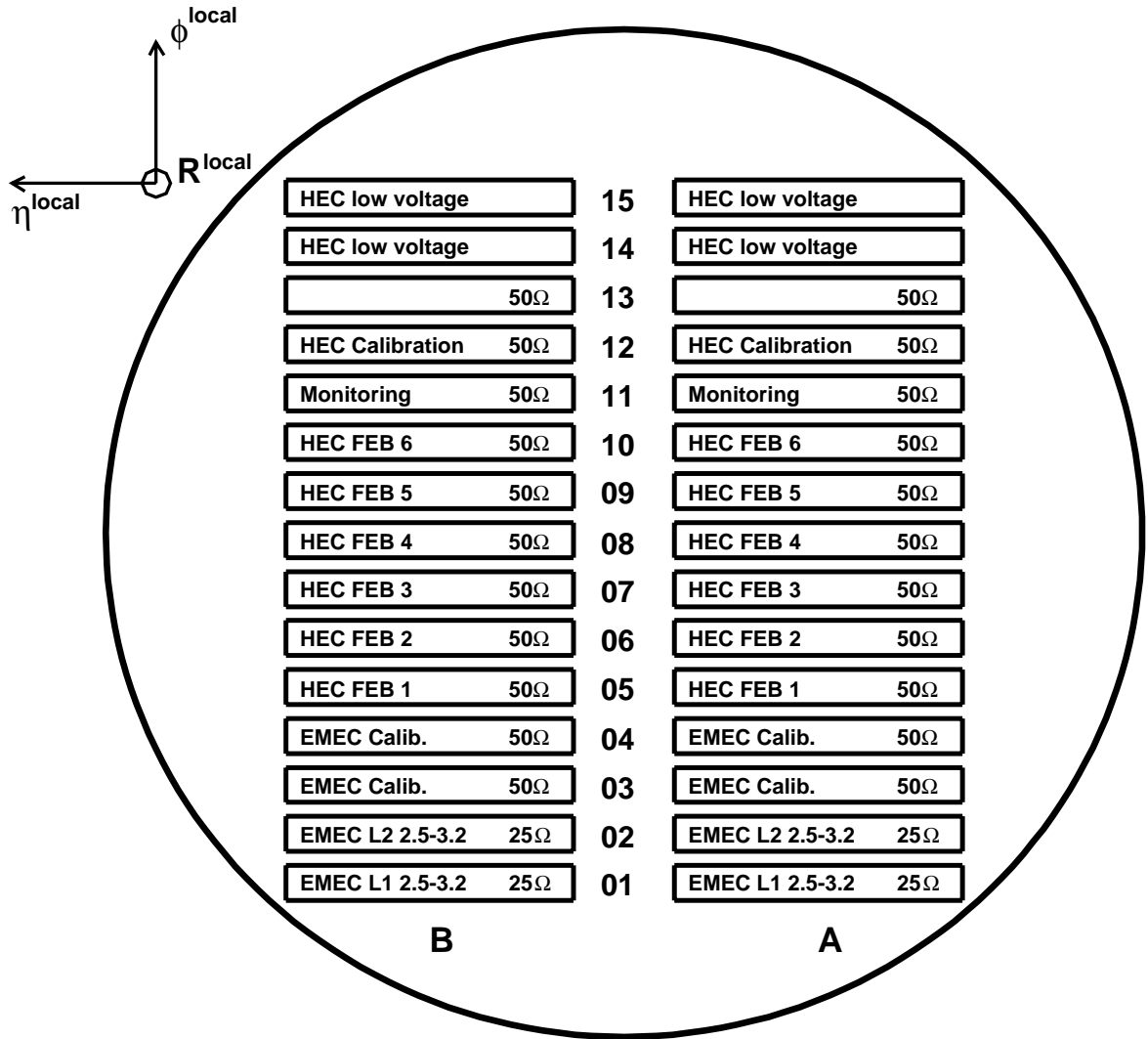

Figure 36: Map of the cold flange seen from liquid argon for the HEC feedthrough servicing both the EM end-cap and the HEC calorimeters. The cable impedance (50 or 25 Ω) together with a calorimeter zone or a function is indicated for each connector.

FCAL FEEDTHROUGH WARM FLANGE (seen from the warm side)

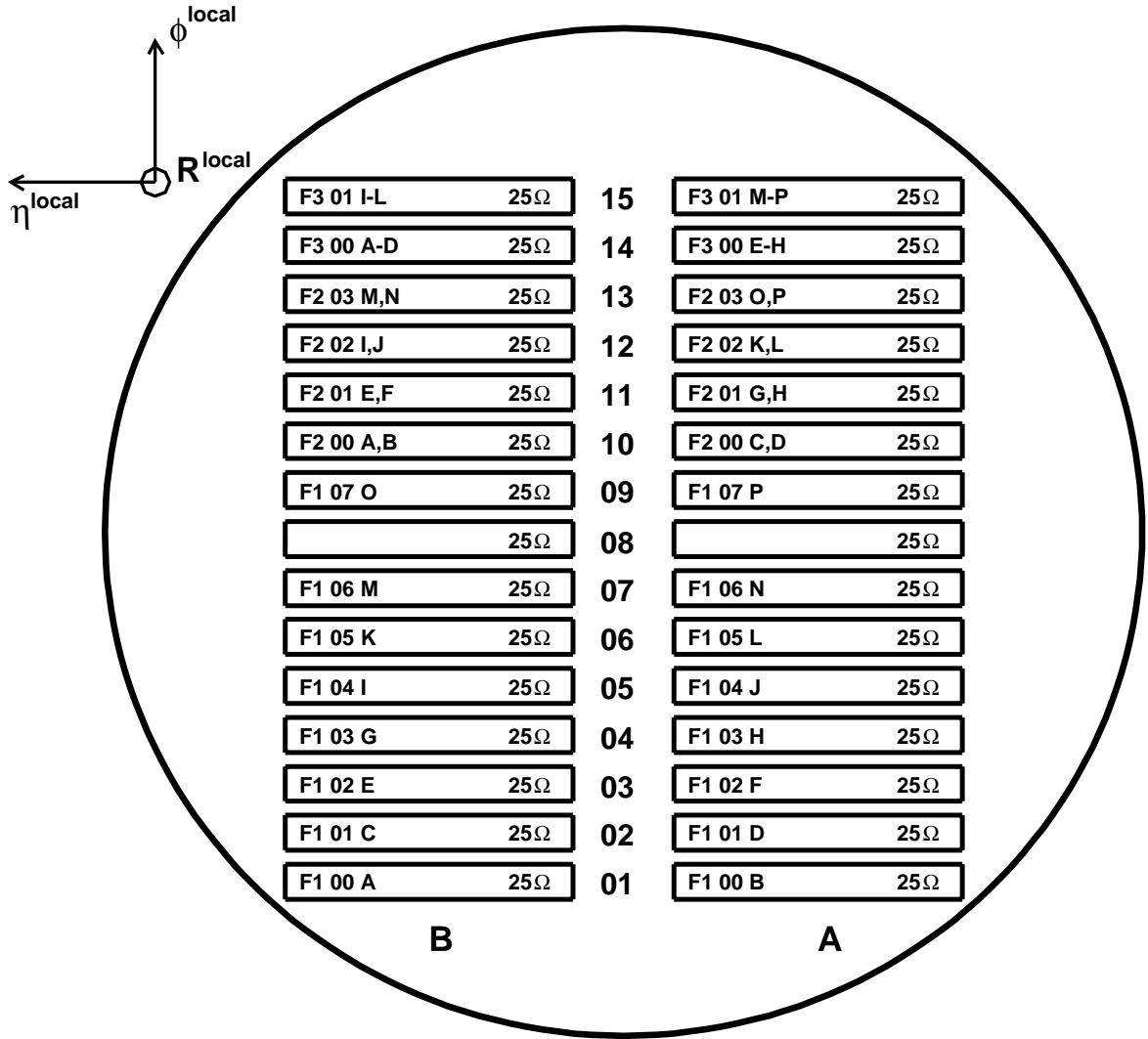

Figure 37: Map of the cold flange seen from liquid argon for the FCAL feedthrough. The cable impedance (50 or 25Ω) together with a calorimeter zone or a function is indicated for each connector.

Flange seen from LAr

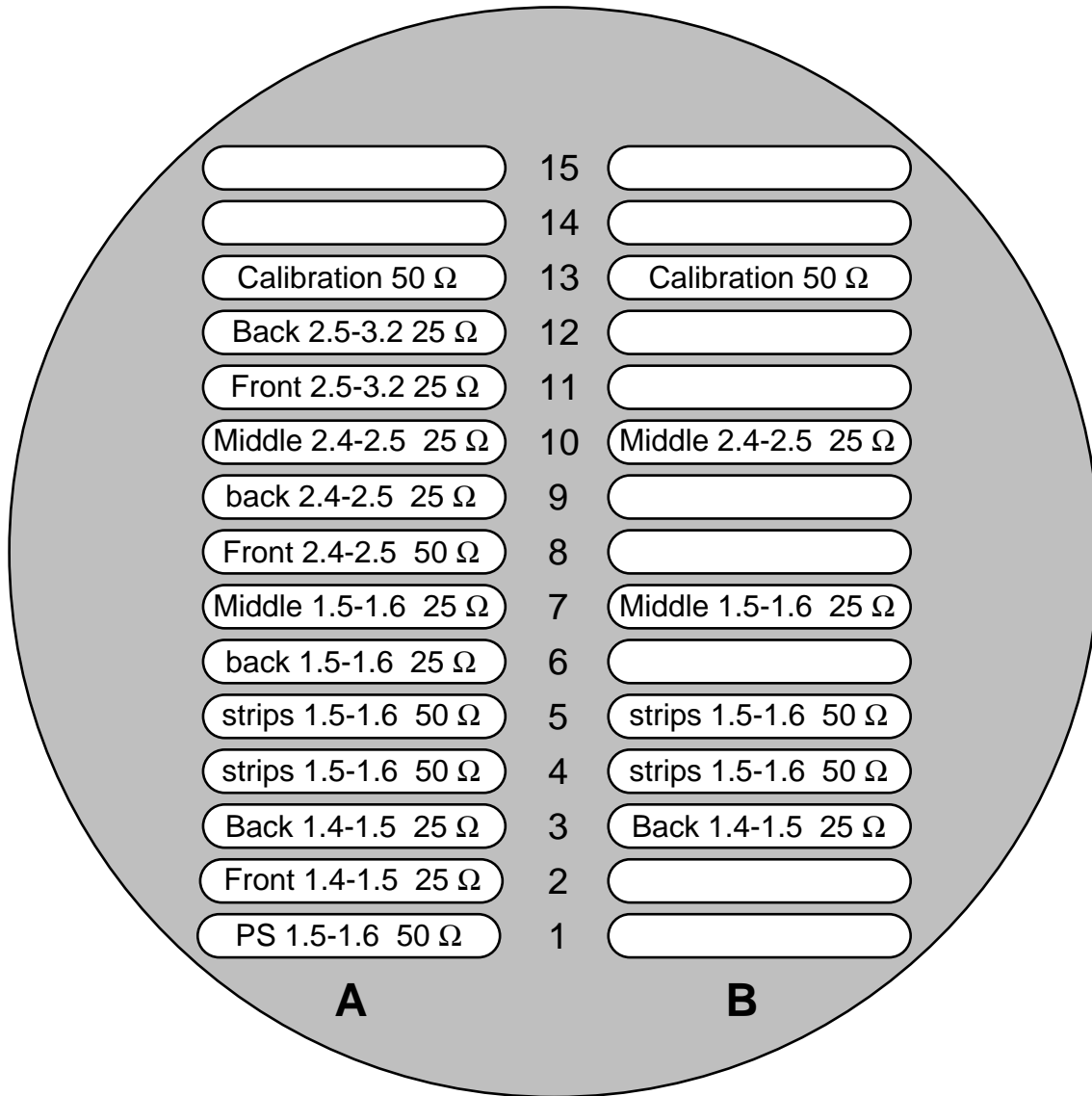
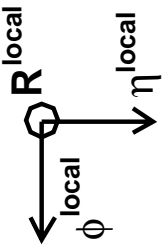

Figure 38: Map of the flange seen from liquid argon for the “special” feedthrough of the NA31 cryostat. The cable impedance (50 or 25Ω) together with a calorimeter zone or a function is indicated for each connector.



EM ENDCAP STANDARD FRONT END CRATE

(seen from the warm side)

38	37	36	35	34	33	32	31	30	29	28	27	26	25	24	23	22	21	20	19	18	17	16	15	14	13	12	11	10	09	08	07	06	05	04	03	02	01
[CAL]	[MONITOR]	[MONITOR]	Monitoring	Middle FEB 2.2-2.4	[MID 3]	Middle FEB 2.0-2.2	[MID 2]	Middle FEB 1.8-2.0	[MID 1]	Middle FEB 1.6-1.8	[MID 0]	Back FEB 2.0-2.4	[BACK 1]	Back FEB 1.6-2.0	[BACK 0]	Controller	[CONTROL]	Tower Builder	[TB]	Front FEB 2.2-2.4	[FRONT 5]	Front FEB 2.0-2.2	[FRONT 4]	Front FEB 1.9-2.0	[FRONT 3]	Front FEB 1.8-1.9	[FRONT 2]	Front FEB 1.7-1.8	[FRONT 1]	Front FEB 1.6-1.7	[FRONT 0]	PS FEB 1.6-1.8	[PS]				

FT 15 14 13 12 11 10 09 08 07 06 05 04 03 02 01 15 14 13 12 11 10 09 08 07 06 05 04 03 02 01 15 14 13 12 11 10 09 08 07 06 05 04 03 02 01

connector 15 14 13 12 11 10 09 08 07 06 05 04 03 02 01 15 14 13 12 11 10 09 08 07 06 05 04 03 02 01

A B

Figure 40: Description of the EMEC standard front end crate with the board functions and how they are connected to the feedthrough flange. The names in brackets are those etched on the baseplane

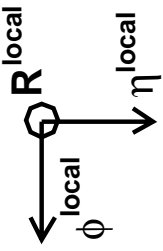

EMEC + HEC FRONT END CRATE

(seen from the warm side)

38	37	36	35	34	33	32	31	30	29	28	27	26	25	24	23	22	21	20	19	18	17	16	15	14	13	12	11	10	09	08	07	06	05	04	03	02	01																																
HEC LV supply	HEC LV supply	[LV SUPPLIES]	HEC Calibration	[MONITORING]	Controller	[MONITORING]	HEC FEB 6	[FEB 6]	HEC Tower Driver	[TDB 2]	[FEB 5]	HEC FEB 5	[FEB 4]	HEC FEB 4	[FEB 3]	HEC FEB 3	HEC Tower Driver	[TDB 1]	HEC FEB 2	[FEB 2]	HEC FEB 1	[FEB 1]	Controller	EMEC Calibration	[CAL 1]	EMEC Calibration	[CAL 0]	L2 FEB 2.5-3.2	[L2]	Tower Builder	[TB 2]	L1 FEB 2.5-3.2	[L1]	Middle FEB 2.4-2.5	[MID 5]	Middle FEB 2.4-2.5	[MID 4]	Tower Builder	[TB 1]	Back FEB 2.4-2.5	[BACK 1]	Front FEB 2.4-2.5	[FRONT 5]	Middle FEB 1.5-1.6	[MID 3]	Middle FEB 1.5-1.6	[MID 2]	Back FEB 1.5-1.6	[BACK 0]	Controller	[CONTROL]	Tower Build 1.5-1.6er	[TB 0]	Front FEB 1.5-1.4	[FRONT 4]	Front FEB 1.5-1.2	[FRONT 3]	Front FEB 1.5-1.6	[FRONT 2]	Front FEB 1.5-1.6	[FRONT 1]	Middle FEB 1.4-1.5	[MID 1]	Middle FEB 1.4-1.5	[MID 0]	Front FEB 1.4-1.5	[FRONT 0]	PS FEB 1.5-1.6	[PS]

FT 15 14 12 11 10 09 08 07 06 05 04 03 02 01 15 14 13 12 11 10 09 08 07 06 05 04 03 02 01 15 14 13 12 11 10 09 08 07 06 05 04 03 02 01

connector 15 14 12 11 10 09 08 07 06 05 04 03 02 01 15 14 13 12 11 10 09 08 07 06 05 04 03 02 01

A B

Figure 41: Description of the EMEC special and HEC front end crate with the board functions and how they are connected to the feedthrough flange. The names in brackets are those etched on the baseplane.

FCAL A FRONT END CRATE
(seen from the warm side)

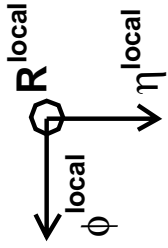

38	
37	
36	
35	
34	
33	
32	
31	
30	
29	
28	
27	
26	
25	
24	
23	
22	
21	
20	
19	F3 01 I-P
18	F3 00 A-H
17	Tower Driver
16	F2 03 M-P
15	F2 02 I-L
14	F2 01 E-H
13	F2 00 A-D
12	Controller
11	F1 07 O,P
10	F1 06 M,N
09	F1 05 K,L
08	F1 04 I,J
07	Tower Driver
06	F1 03 G,H
05	F1 02 E,F
04	F1 01 C,D
03	F1 00 A,B
02	Calibration
01	[MONITOR]

FT connector

15 14	13 12 11 10	09 07 06 05	04 03 02 01	A
15 14	13 12 11 10	09 07 06 05	04 03 02 01	B

Figure 42: Description of the FCAL A front end crate with the board functions and how they are connected to the feedthrough flange. The names in brackets are those etched on the baseplane.

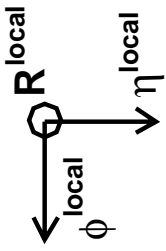

FCAL C FRONT END CRATE

(seen from the warm side)

38	F3 01 I-P	
37	F3 00 A-H	
36	Tower Driver	[TDB 1]
35	F2 03 M-P	[F2 03]
34	F2 02 I-L	[F2 02]
33	F2 01 E-H	[F2 01]
32	F2 00 A-D	[F2 00]
31	Controller	[CONTROL]
30	F1 07 O,P	[F1 07]
29	F1 06 M,N	[F1 06]
28	F1 05 K,L	[F1 05]
27	F1 04 I,J	[F1 04]
26	Tower Driver	[TDB 0]
25	F1 03 G,H	[F1 03]
24	F1 02 E,F	[F1 02]
23	F1 01 C,D	[F1 01]
22	F1 00 A,B	[F1 00]
21	Calibration	[CAL]
20	Monitoring	[MONITOR]
19		
18		
17		
16		
15		
14		
13		
12		
11		
10		
09		
08		
07		
06		
05		
04		
03		
02		
01		

FT 15 14 13 12 11 10 09 07 06 05 04 03 02 01
connector 15 14 13 12 11 10 09 07 06 05 04 03 02 01

A
B

Figure 43: Description of the FCAL A front end crate with the board functions and how they are connected to the feedthrough flange. The names in brackets are those etched on the baseplane.

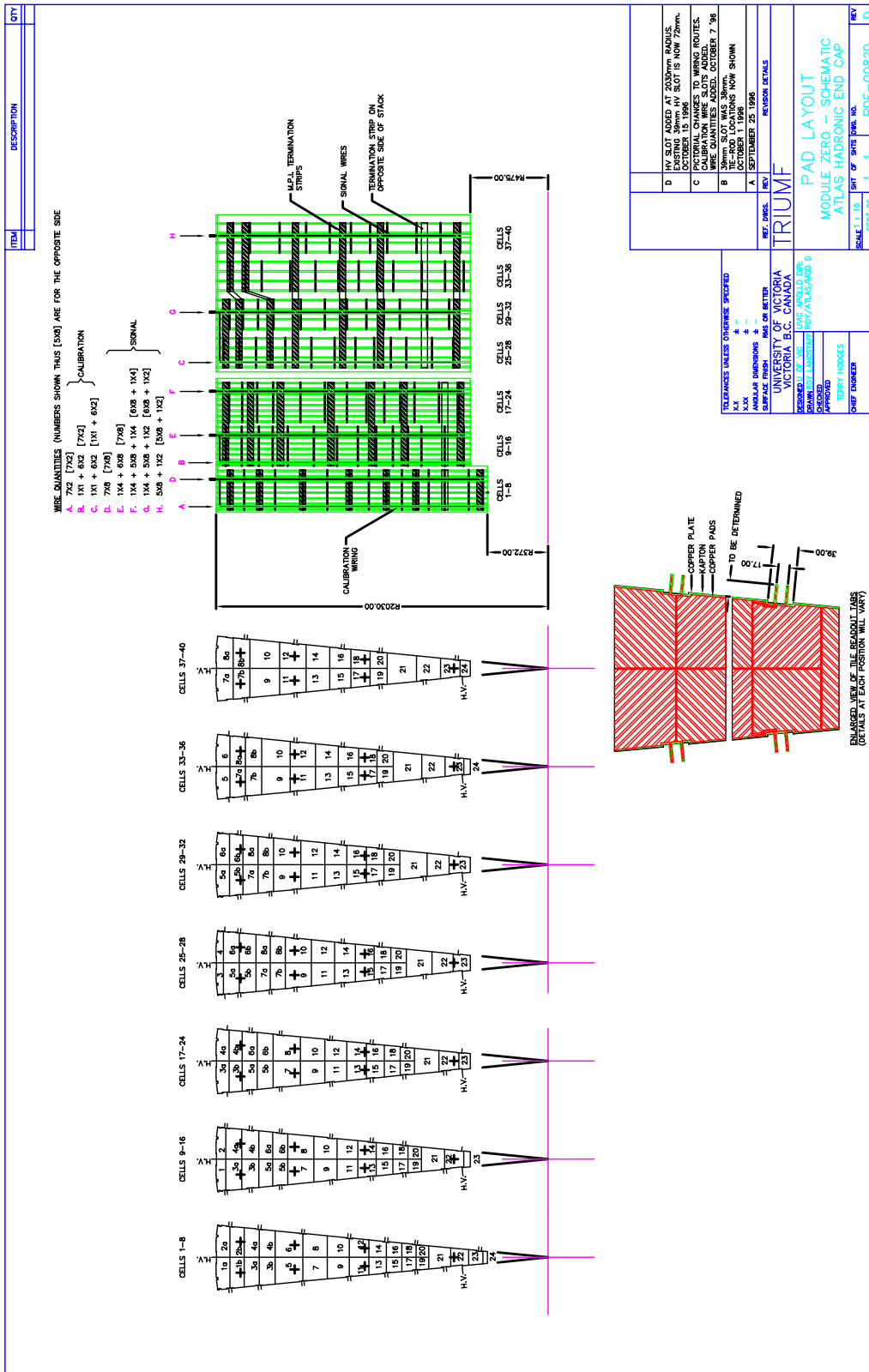

Figure 44: Lateral and longitudinal segmentation of the front and rear module.

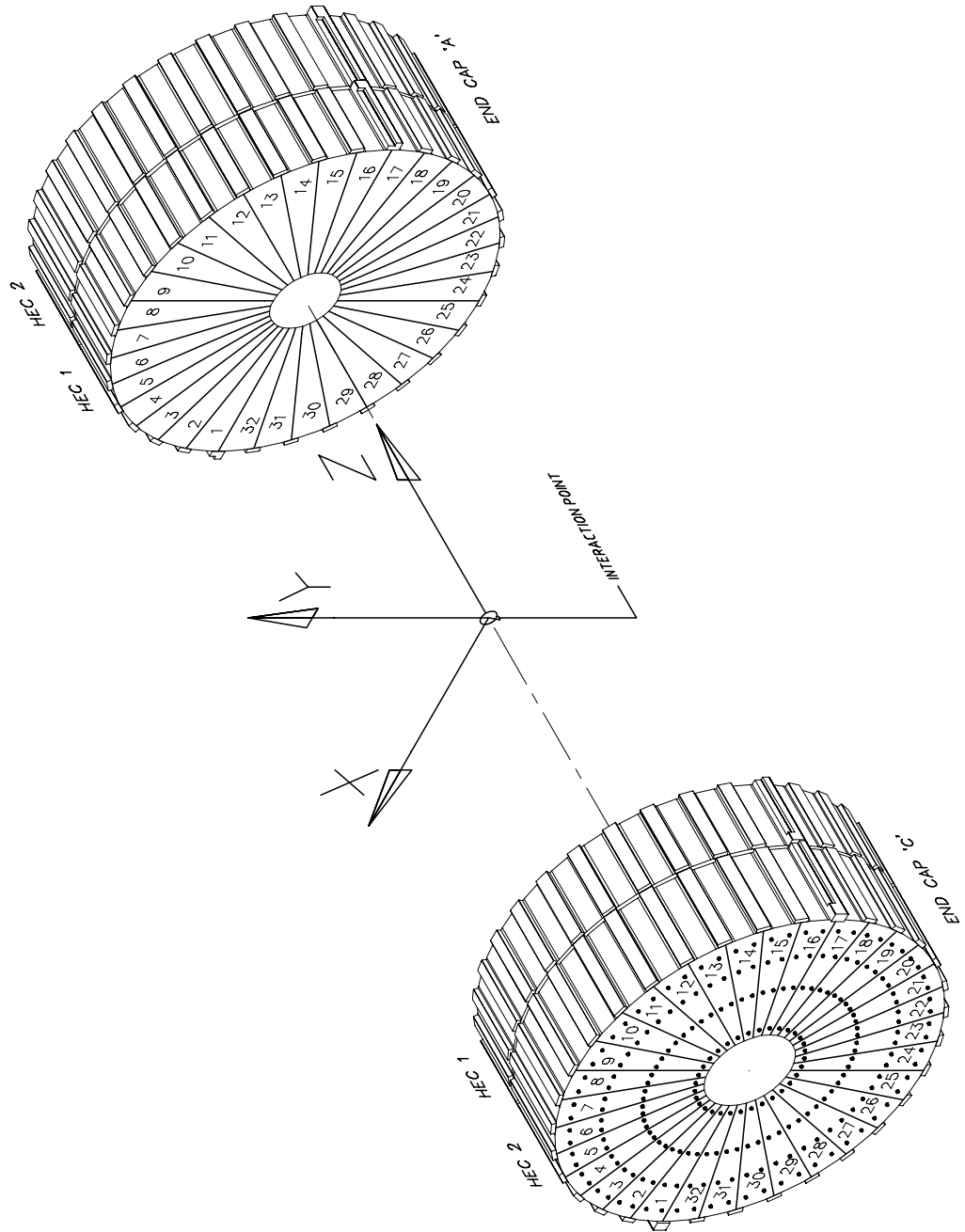

Figure 45: The two HEC endcaps with the module numbering scheme.

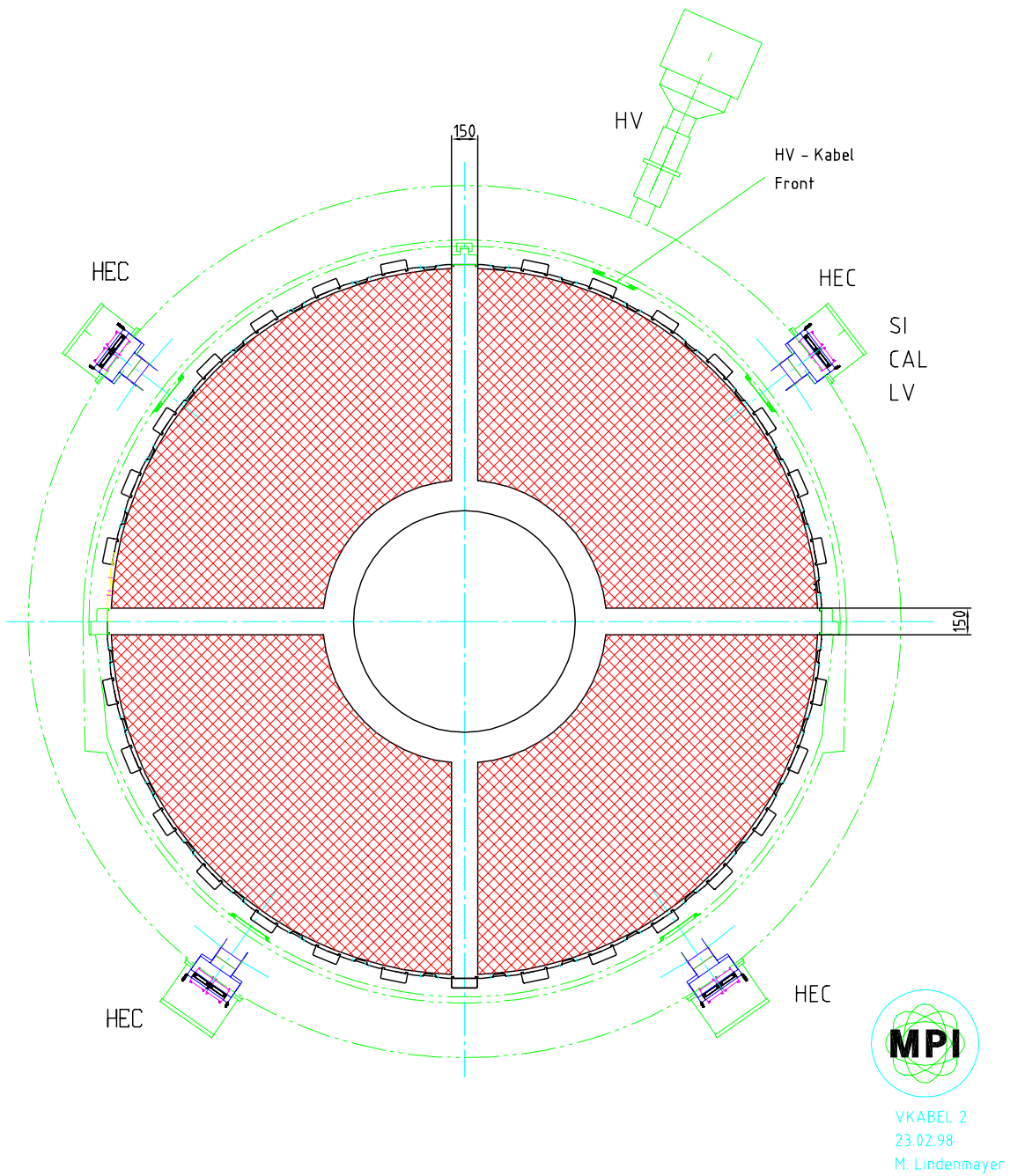

Figure 46: Overall layout of the cabling scheme for the rear wheel HEC2 ($R - \phi$ view). The hatched area indicates the space taken by the arrangement of the patchpanels.

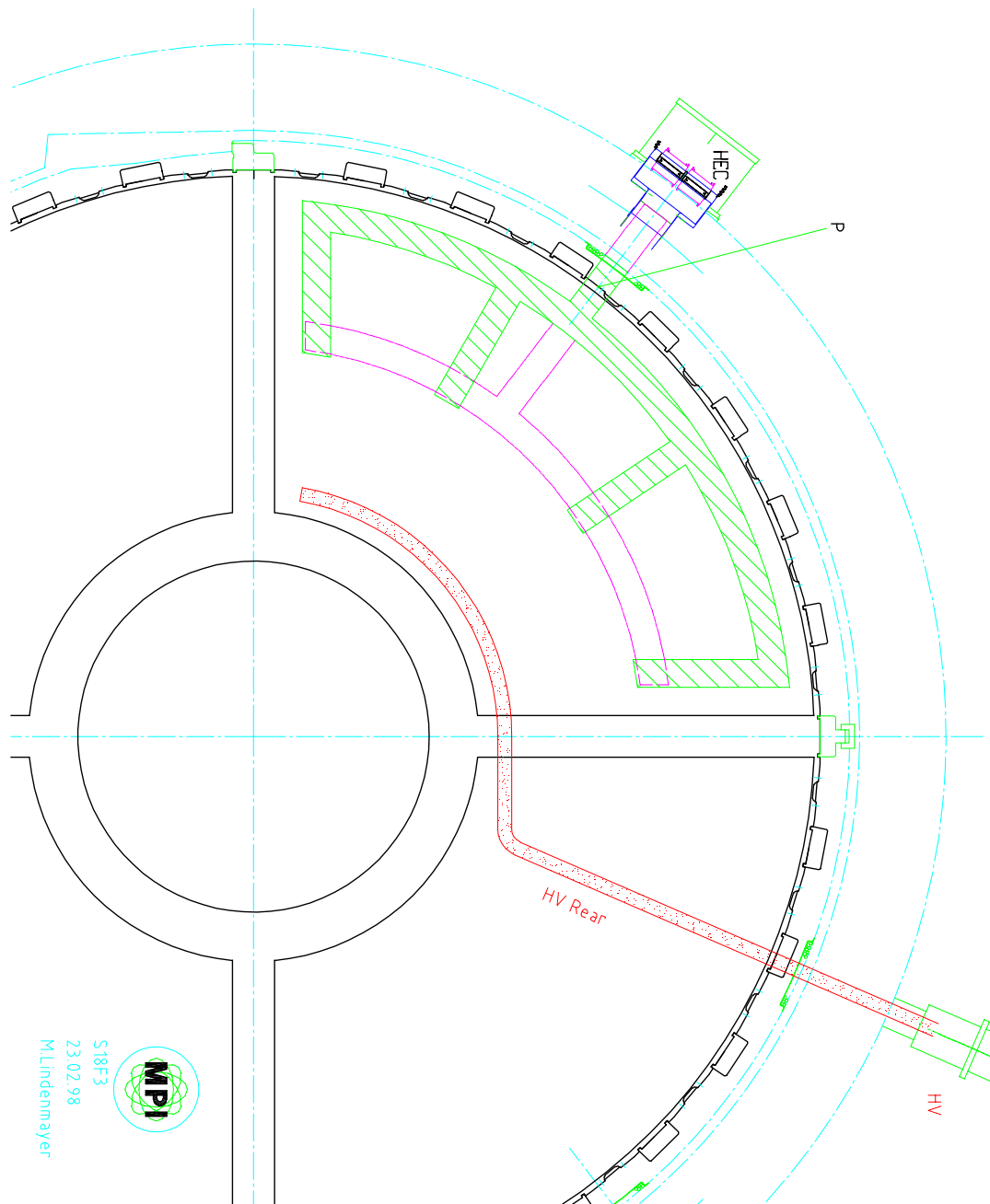

Figure 47: Layout of the cabling scheme in $R - \phi$ for one quadrant. Shown is the space reserved for the coming (pigtails, hatched) and outgoing cables at the level of the patch-panels on the backplane of the rear wheel HEC2.

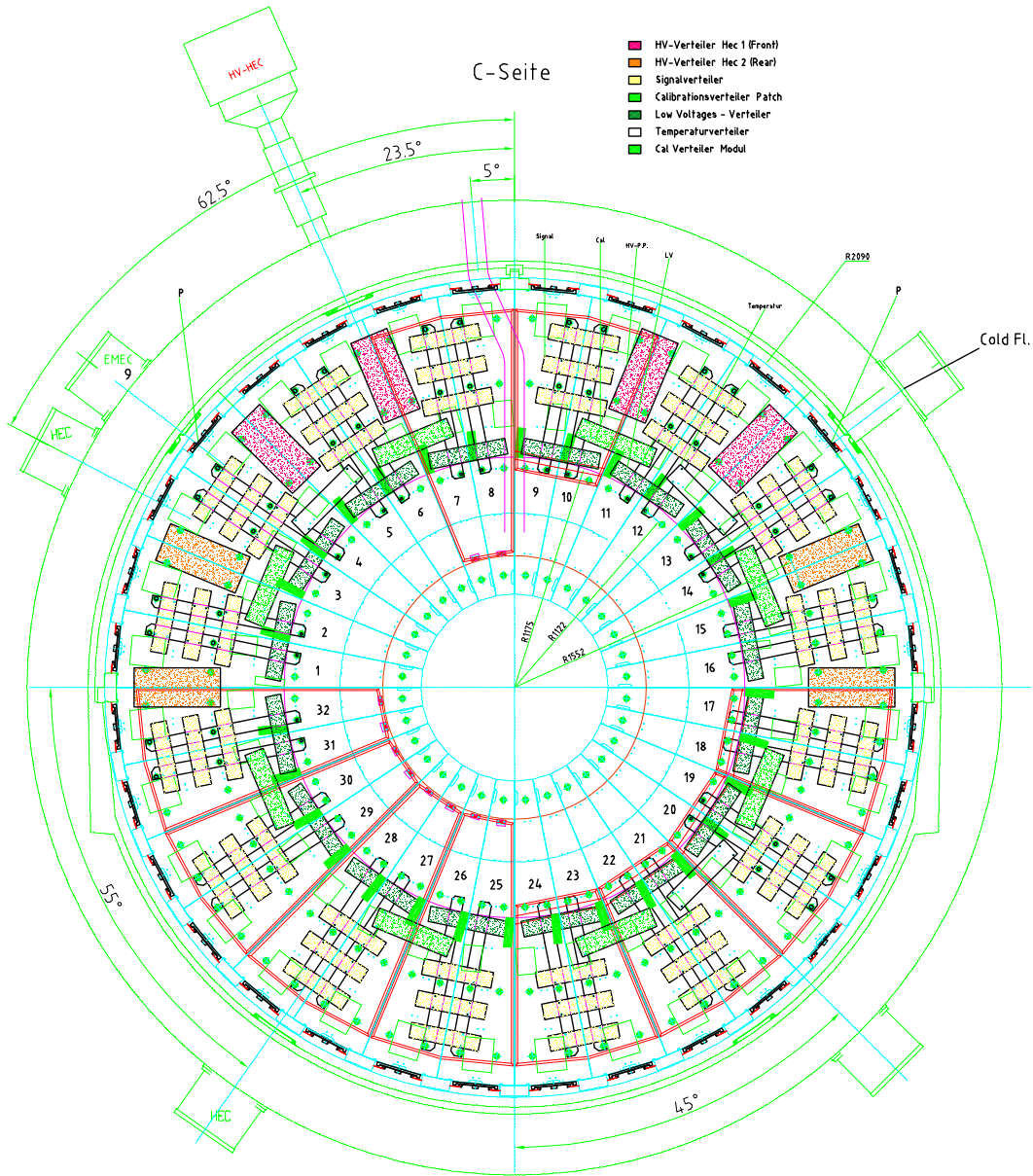

Figure 48: Distribution of the patchpanels (signal, low voltage, calibration) at the backplane of the rear wheel HEC2 and signal cabling in $R - \phi$.

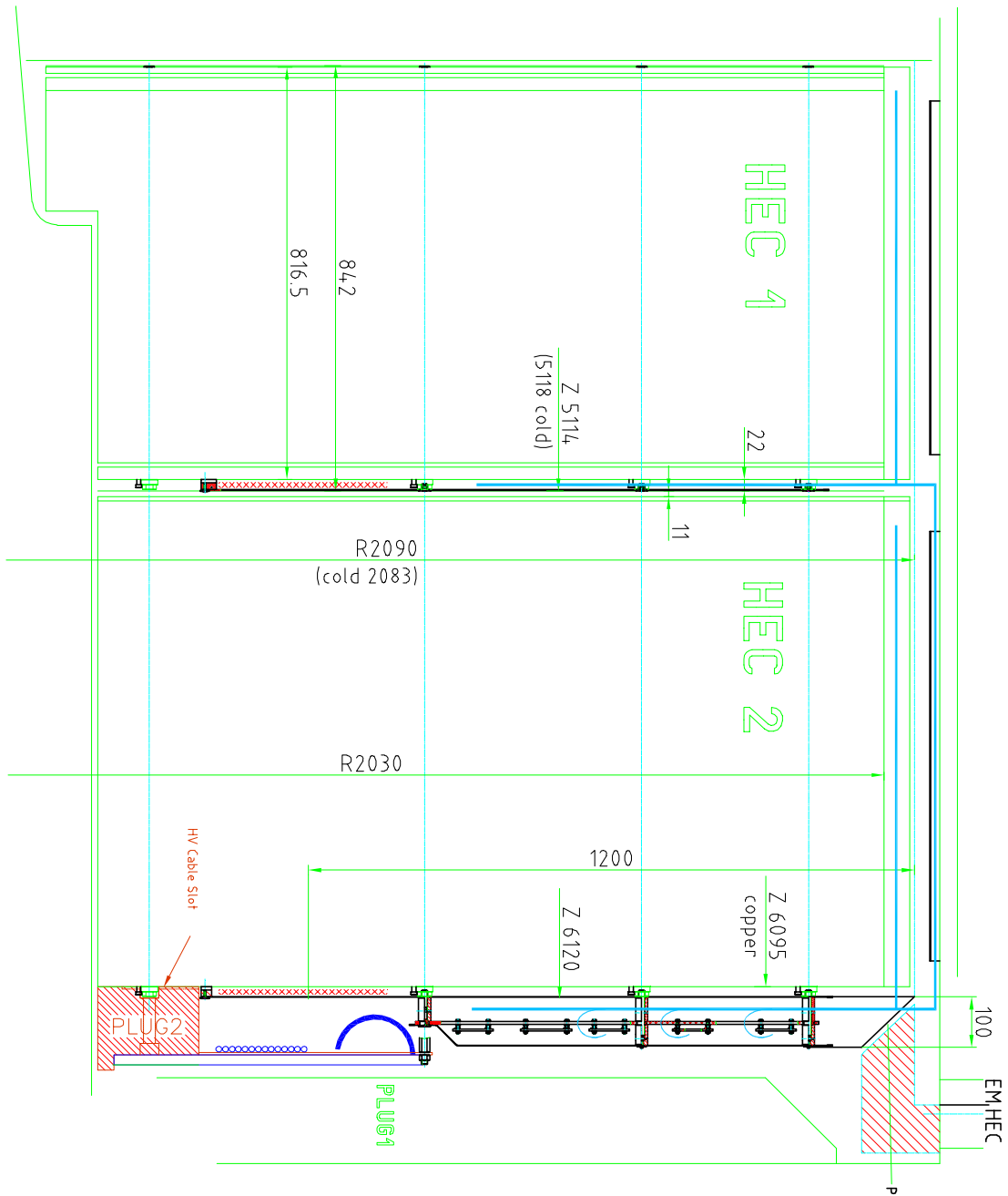

Figure 49: Cabling scheme for the signal cabling in $R-z$.

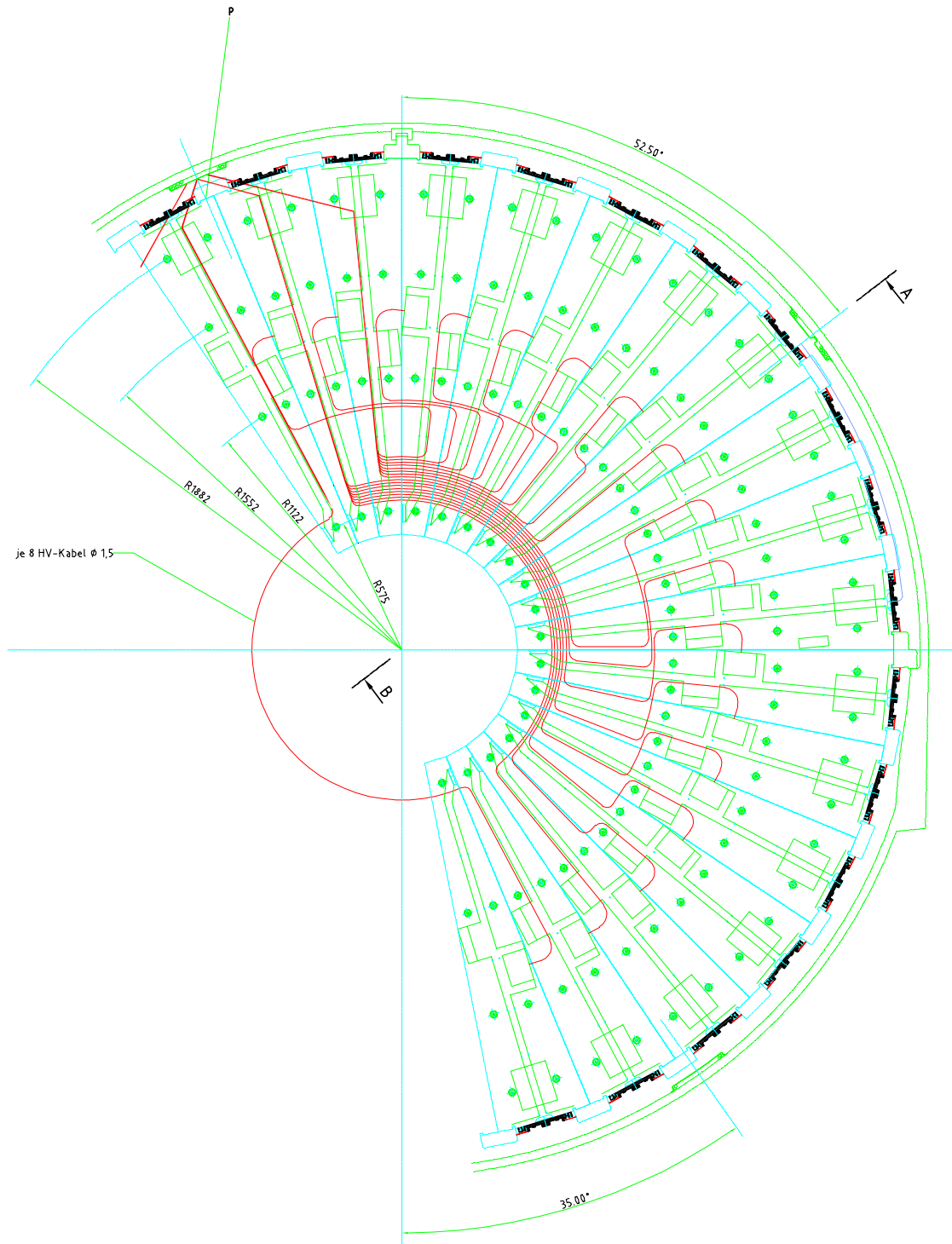

Figure 50: HV cabling scheme in $R - \phi$.

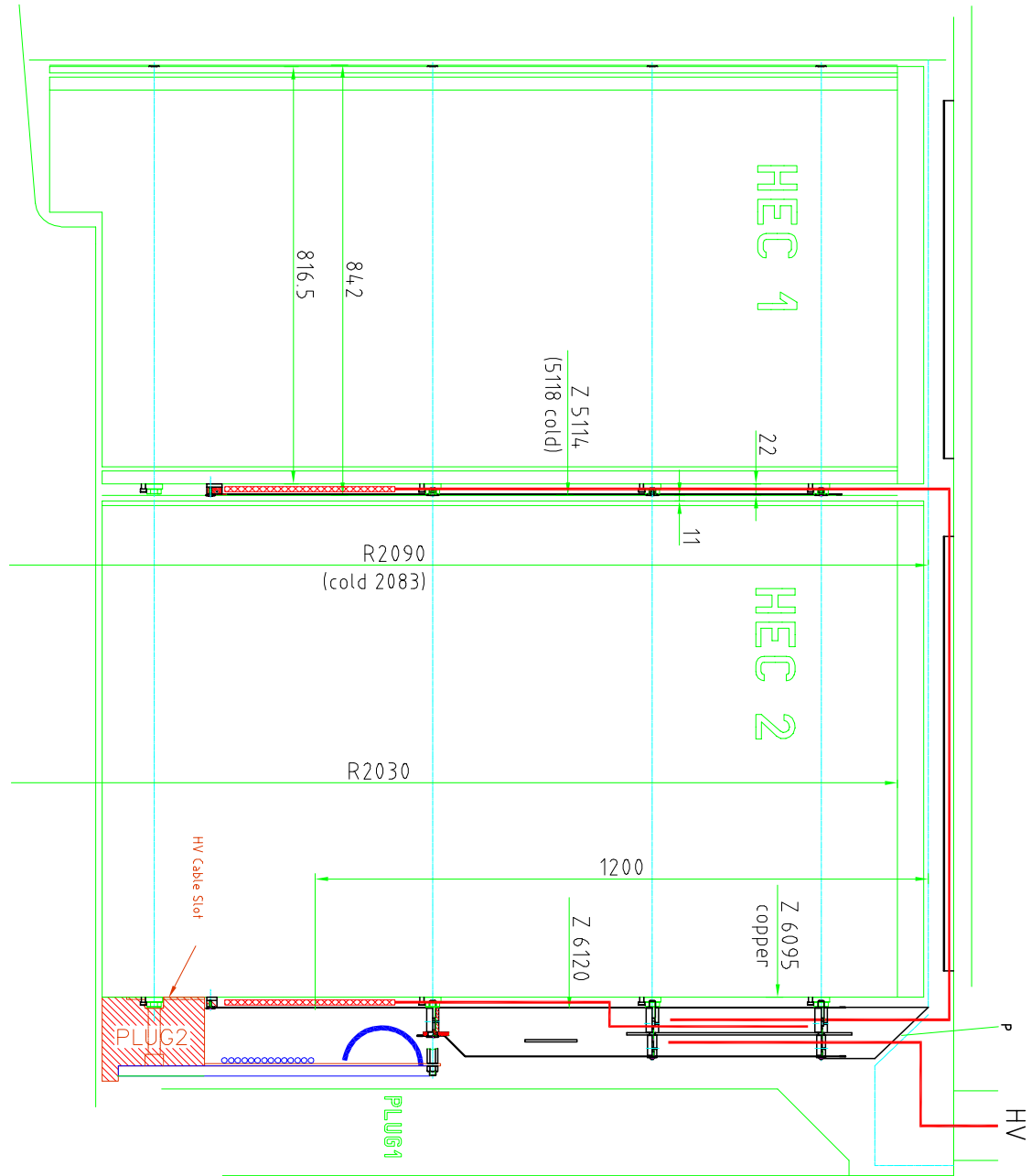

Figure 51: HV cabling scheme in $R - z$.

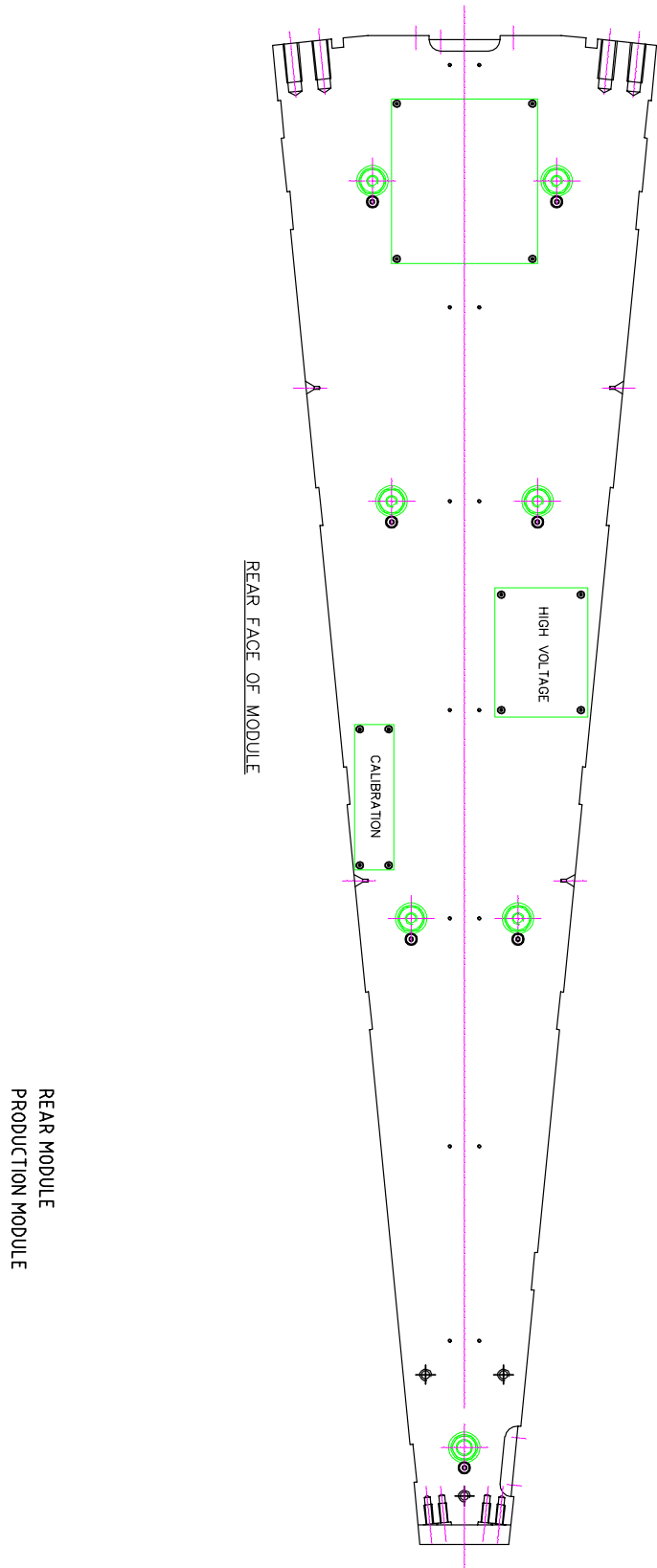

Figure 52: Schematic view of the back plane of a module. Shown is the space allocated for individual boards (calibration and high voltage) and for additional extra cable length.

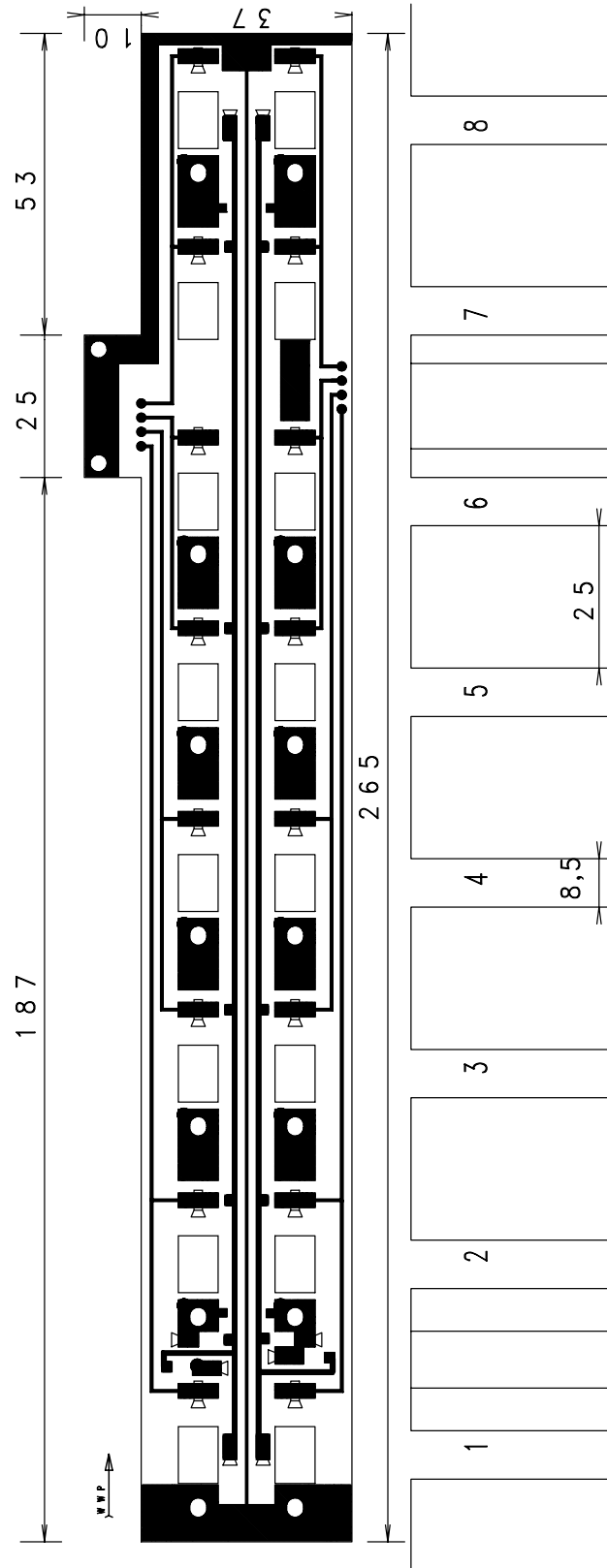

Figure 53: Layout of the signal strip line connector. The back plane serves as ground bus. All conducting surfaces are gold plated.

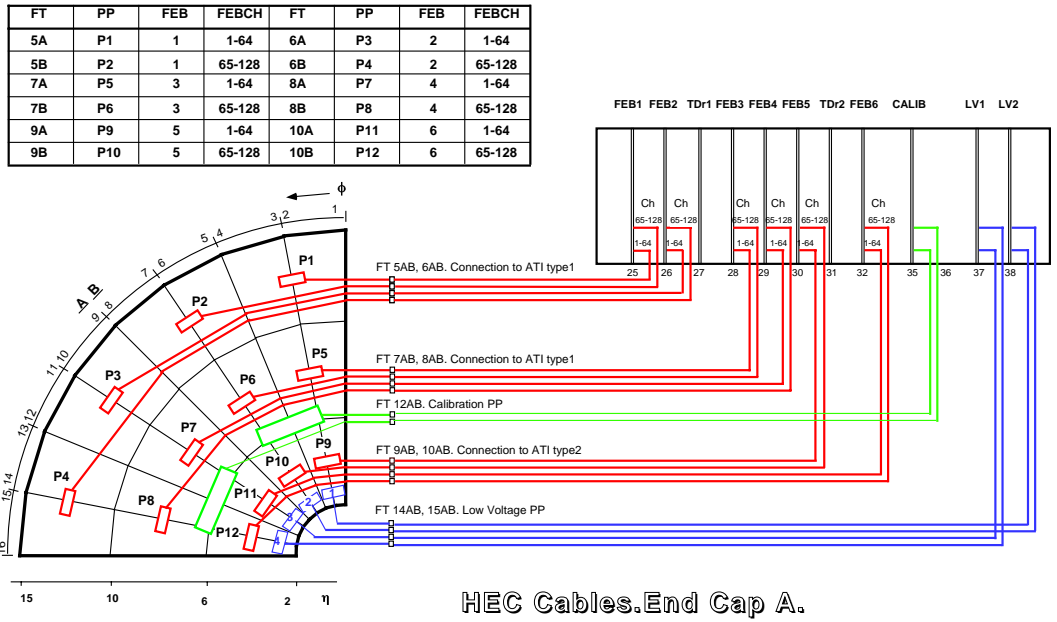

Figure 54: Overview of the signal, LV and calibration cabling for one quadrant of endcap A. Shown are the lines from the patch panels at the rear plane of HEC2 up to FEB boards, including the feed-through connector assignment.

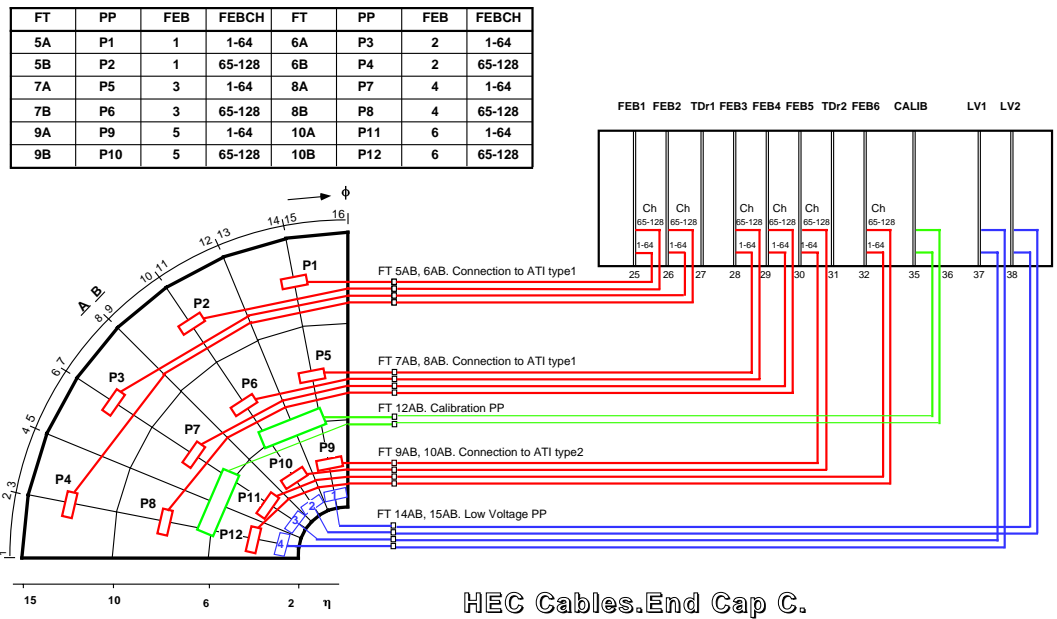

Figure 55: Overview of the signal, LV and calibration cabling for one quadrant of endcap C. Shown are the lines from the patch panels at the rear plane of HEC2 up to FEB boards, including the feed-through connector assignment.

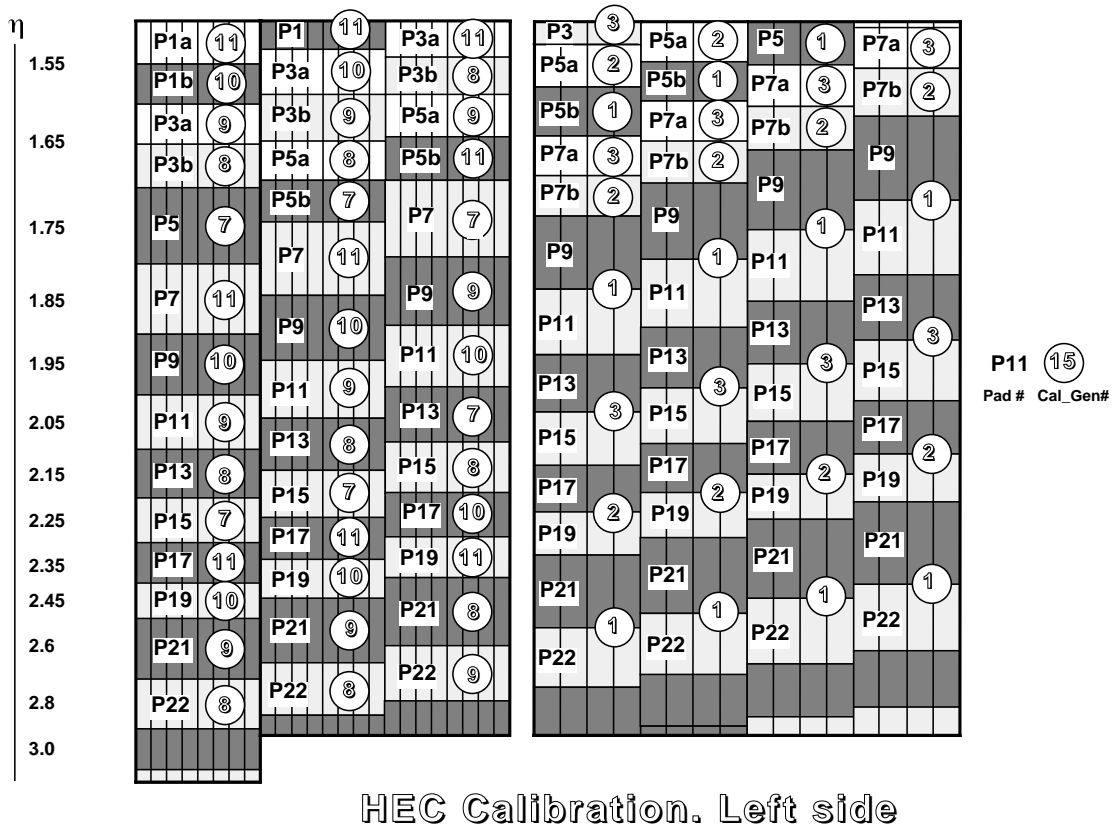

Figure 56: Assignment of calibration lines to signal pads for the left side of the front and rear HEC module.

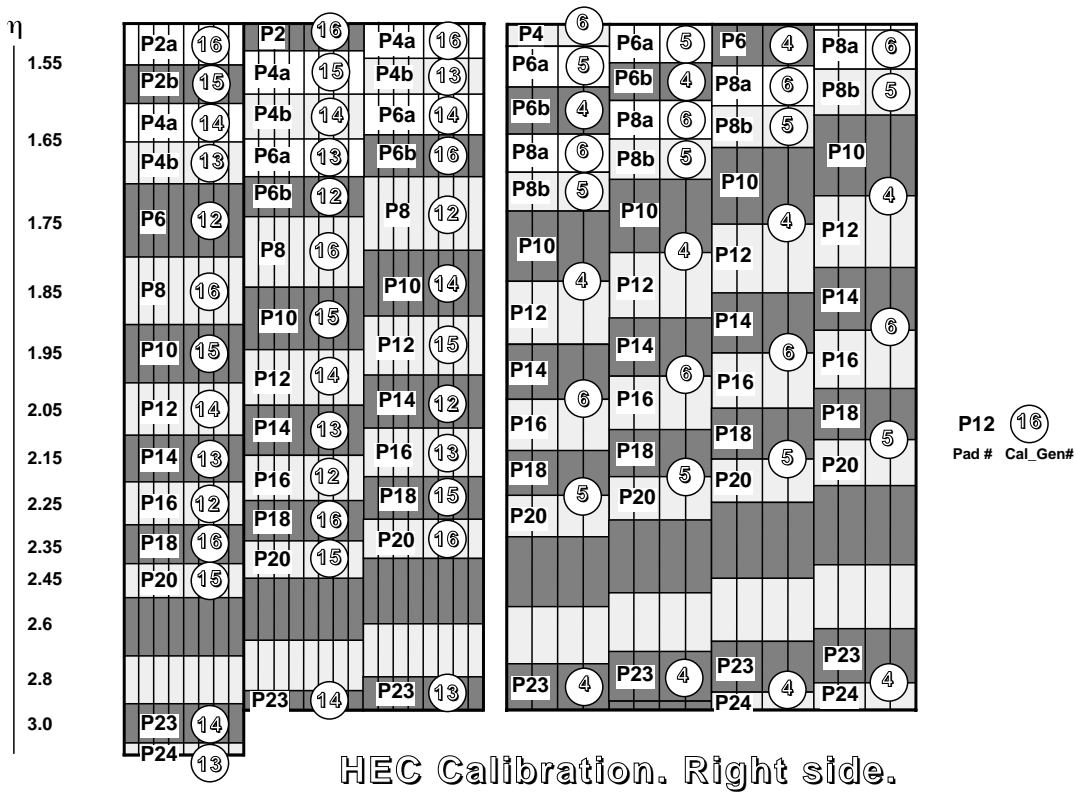

Figure 57: Assignment of calibration lines to signal pads for the right side of the front and rear HEC module.

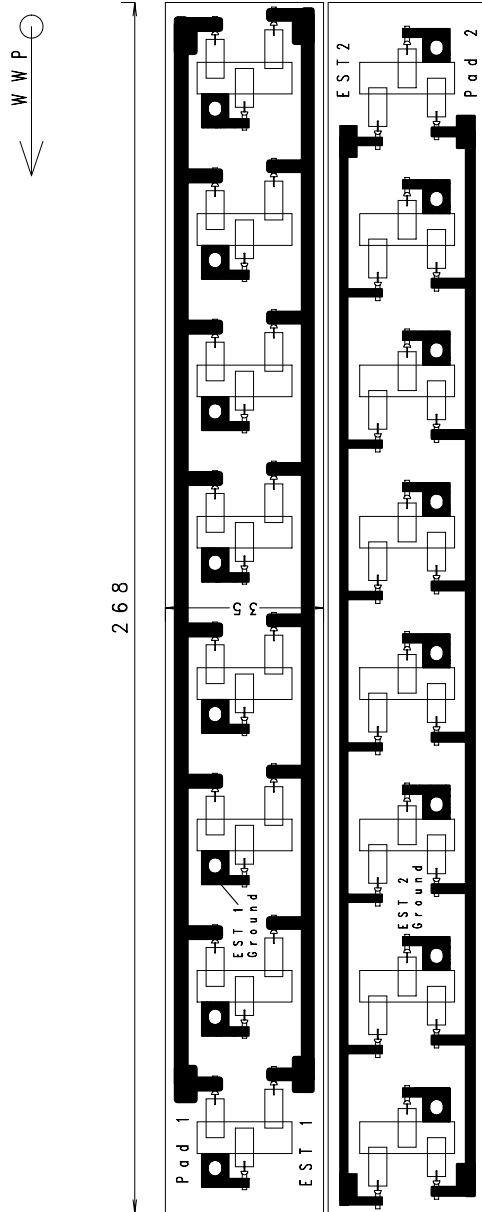

Figure 58: Layout of the HV strip line connector. Two connectors, with the second one rotated by 180 degrees, are used to serve for the four HV and two ground connections required per LAr gap.

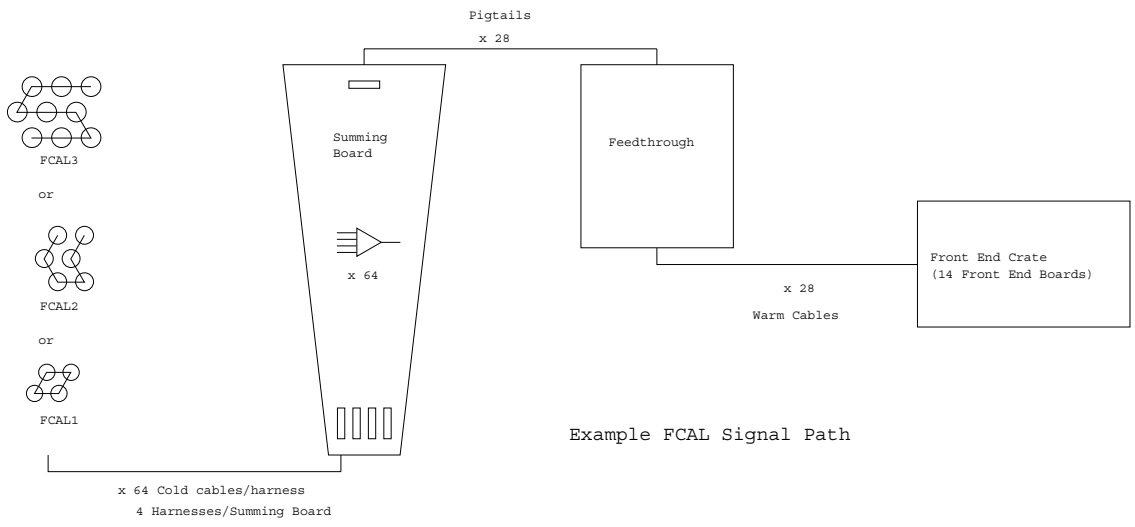

Figure 59: Cabling scheme for the FCAL

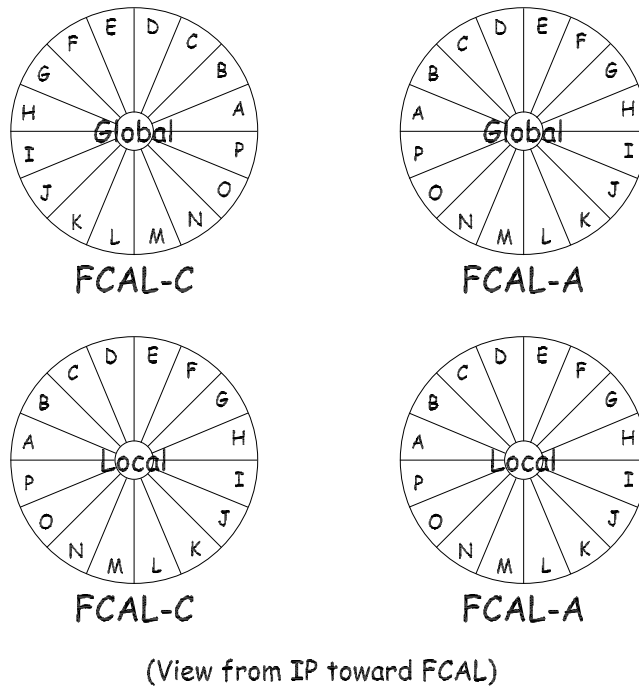

Figure 60: Global coordinates convention for the FCAL wheel